

GREAT AMERICAN



MINIATURE DONKEY SALE™

**Saturday July 31, 2004
Historic Lebanon, Ohio - Fairgrounds**

.....
***Select Miniature Donkeys from Breeders
Across North America***
.....

***Quality Conformation, Diverse Pedigrees, All Colors, 90% Jennets,
10% Outstanding Jacks, and a Driving Team***
.....

**Visit WWW.DONKEYS.NET for
Web Catalog with pictures**
.....

Sale Sponsors
Elms Farm Miniature Donkeys
The Elms Farm
Martha & Dowell Howard
Mason, Ohio
donkeys@donkeys.net
513-398-3341

Welcome To
The Great American Miniature Donkey Sale
Saturday, July 31, 2004
Historic Lebanon, Ohio – Fairgrounds

June 2004

Dear Donkey Enthusiast,

We are pleased to invite you to The Great American Miniature Donkey Sale, a select sale featuring quality registered miniature donkeys. The Sale will take place Saturday, July 31, 2004 at 12:30 PM, at the fairgrounds in historic Lebanon, Ohio. We hope you will plan to attend.

The Sale will consist of 54 miniature donkey lots comprised of 46 jennets, 6 jacks, and a sorrel gelding driving team. These miniature donkeys have been selected from those offered. Top breeders are consigning their best, as those donkeys represent their farm and breeding program. It would literally take you many days and thousands of miles to view an assortment of available, quality stock like that you can see represented at the Sale. The donkeys being offered represent diverse bloodlines, great conformation, sought after colors, and a variety of sizes and ages to attract breeders, show people, and donkey and equine lovers everywhere. Full information on each donkey, including pictures (as consignors make them available), may be found on our web page, www.donkeys.net.

There is something for everyone here, whether you are an experienced breeder, or just getting started. The jennet group features; yearlings, 2 year olds, mature jennets, bred jennets, and jennets with foals on the side. The 6 jacks are top quality with great structure and desirable bloodlines, ready to begin using now, including one trained to drive who is being sold with cart & quality Amish harness. A driving team is also being offered, giving you a chance to continue in, or enter into, this fun activity. Donkey tack, gifts and curios will be available for purchase. Whether you are looking for jennets, a stud, a jennet with foal, brood jennets for your breeding program, a trained driving team or a loving pet, you are assured of finding only quality miniature donkeys at this sale.

The Great American Miniature Donkey Sale is more than a donkey sale; it is an event, a 'happening'. Donkey enthusiasts everywhere look forward to events such as this and we expect a large turnout from across the Continent. It is an opportunity for folks, both those with years of experience, and those first exploring miniature donkeys, to get together, share experiences, learn from each other, have some fun, make new friends, renew old friendships, and, oh yes, see, bid on, and purchase some of the finest quality miniature donkeys in North America.

We hope you plan to attend the 2004 Great American Miniature Donkey Sale. We feel confident you will enjoy it.

Thank You for Your Support

Martha L. Dowell Howard

PS – If you can't attend, but want to bid on the donkeys, please contact us before July 27. Sale Day telephones 513-225-1771 and 513-919-5613.

The Great American Miniature Donkey Sale

Schedule of Events

FRIDAY JULY 30, 2004 SALE SET-UP DAY

Friday is primarily a set-up and check-in day for the Sale. All donkeys must be on site by 4:00 to allow for consignor and vet check-in. At approximately 5:00, the donkey heights will be taken. There will be limited viewing during the late afternoon. The consignor's dinner will follow check-in and measurement.

Viewing Begins	3:00	
Measurement	5:00	(Approximate)
Consignor's Invitational Dinner	6:30	

SATURDAY JULY 31, 2004 SALE DAY

Saturday is the Sale Day. Viewing will begin at 8:00. Breakfast & lunch will be available for purchase from the local 4H Club. There will be a Silent Auction of donated donkey related items starting at 9:30, with proceeds going to benefit NMDA donkey research programs. Please bring your donations to the Sale. The Donkey Sale starts at 12:30 and checkout begins shortly after the last lot is sold.

Donkey tack, gifts, useful items and curios will be available from The Donkey Store.

Viewing Begins	8:00
Sale Vendors	8:00
Silent Auction Start	9:30
Sale Starts	12:30
Payment, Vet Papers	Shortly after last lot is sold
Silent Auction ends	20 minutes after the Sale
All Donkeys Gone	before 8:00 PM

SUNDAY AUGUST 1, 2004 THE ELMS FARM OPENHOUSE

We would like to invite everyone to The Elms Farm open house Sunday after the Sale from 8:30 until ?. We're only about 8 miles from Lebanon and are situated between I-75 and I-71 for easy access. Directions are available on the web site and will also be available at the Sale. Stop by and see our herd, have some refreshments, and talk donkey. We are looking forward to seeing you.

Sale Directions

The Donkey Sale will be held in Building C, at the Warren County Fairgrounds in Lebanon, OH. You enter through Gate 4. From I-75, take exit #29 (Monroe, Lebanon Rt 63) east to Lebanon, 7 miles. Turn left on Broadway (Rt 48 North), go 0.7 miles to the fairground. From I-71, take exit #28, Rt 48, turn North, go to Rt 123, exit toward Lebanon, go 1 mile, turn right on Broadway go 0.7 miles to the fairground

Auctioneering & Clerking

Kevin Wendt, Auctioneer

5665 Esplanade St.

Columbus, OH 43221

614-876-2328

The Great American Miniature Donkey Sale

TERMS AND CONDITIONS

Terms: Terms of the sale are cash or good check, with photo identification. All donkeys must be paid for immediately at sale end. No animals may be removed prior to close of the sale, and all donkeys must be removed from the premises by 8 PM, unless other arrangements have been made with the sponsors.

Bidding: All donkeys sell to the highest bidder. Any disputes or challenges will be settled by the auctioneer, and the auctioneer's decision will be final. The auctioneer may reject any or all bids. Bids are per lot. Jennets with foals on the side sell as one lot. Driving teams sell as one lot.

Risk: The owner assumes all risk for the donkey up to the point of sale. The buyer assumes all risk at the moment the auctioneer declares the animal is sold. The management is not responsible for loss or damages to personal property.

Announcements: All announcements on sale day from the auction block will take precedence over the material printed in this catalog. Every effort has been made to ensure the accuracy of the catalog. However, we assume no liability for errors or omissions.

Contract: The management, auctioneers, and employees act as agents for the seller, but assume no liability for either the buyer or the seller. Any representations made by the sales management are made on behalf of the seller.

The above terms and conditions shall constitute a contract between the buyer and the seller of each animal sold. All guarantees are between buyer and seller.

Health: The EIA/Coggins test will be less than 6 months old. Current health papers for transportation with state stamp, should be good for 7 days past sale date. Proof of pregnancy from a veterinarian is required for bred jennets, otherwise sold as exposed. Buyers are responsible to obtain the paperwork they need from the veterinarian after payment immediately following the sale.

Transport: We may be able to help you get your donkey(s) home. Please let us know if you may need this assistance.

General: Please note that donkey heights in the catalog have been provided by the seller. These may be adult or immature heights and are included only as helpful data. We encourage you to measure donkeys you are interested in purchasing, if the data provided seems inaccurate via visual inspection. All donkeys will be measured in public view at a designated area after arrival at the fairgrounds. Time to be announced.

Absentee/ Phone Bids

Please contact Dowell or Martha Howard at 513-398-3341 by July 27 for details on how they will be handled.

Please Bring This Catalog – Supplies Are Limited

The Great American Miniature Donkey Sale

Camping & Lodging

Camping: Camping is available Friday night at the Fairgrounds for \$10. Water & electric hook-ups, dump station, restrooms & showers, HOT water. 250 ft from the Sale Pay fee to Dowell or Martha Howard.

Historical Lodging: The Golden Lamb, 27 S. Broadway, Lebanon, OH 45036, 513-932-5065, goldenlamb.com, Ohio's oldest inn, 200 years of US history. 8 Presidents, Mark Twain & Charles Dickens stayed here, 1 mile to the Sale

Bed & Breakfast: The Hatfield Inn, 2563 Hatfield Rd, Lebanon, OH 45036, 513-932-3193 or 888-247-9793, www.bbonline.com/oh/hatfield/, 1810 renovated home on 55 Ac farm, large rooms. 5 miles to Sale. nice, breakfast, Double \$85, single \$65,

Motels – Just a selection, many more listed on the web
 indicates where people have told us they enjoyed staying in the past

Motel	Miles to sale	Quoted July 04 Rates	Address	Telephone #	Web
Lebanon I-71 Exit #28 or I-75 Exit #29					
Golden Lamb	1	\$87.00 \$113.00	27 S Broadway Lebanon, OH 45036	513-932-5065	goldenlamb.com
Shaker Inn	 2	\$62.00 \$72.00	600 Cincinnati Av. (on Route 42) Lebanon, OH 45036	513-932-7575 800-752-6151	shakerinnmotel.com Contact Andrea
I-71 Exit #25					
Super 8 Motel Kings Island*	 9		4110 U.S. Route 42 Mason, OH 45040	513-398-7060 800-800-8000	super8.com
Kirkwood Inn*	 9	\$79.95 & Up	4030 S US Rte 42 Mason, OH 45040	513-398-7277 800-732-4741	kirkwoodinn.com Sandy or Dave
I-75 Exit #29					
Super 8 Motel Monroe	 8		150 New Garver Rd Monroe, OH 45050	513-539-9221 800-800-8000	super8.com
Days Inn	8		120 Senate Dr Monroe, OH 45050	513-539-2660 800-329-7466	daysinn.com
Hampton Inn	8		40 New Garver Rd Monroe, OH 45050	513-539-4400 800-hampton	hamptoninn.com

* near Houston restaurant – reasonable priced American food – great salad bar

Elms Farm Miniature Donkeys

**We strive to produce quality miniature donkeys with excellent conformation,
great dispositions and personalities**

- * **Correct drafty donkeys, with emphasis on sorrels, blacks, and darks.**
- * **Large sorrel herd, one of the most genetically diverse anywhere.**
- * **6 Herd Sires - 4 sorrel, 2 black**
- * **Every foal carries sorrel or black genes or both.**
- * **Breed stock selected from herds across North America**
- * **Each mating planned to strengthen desirable characteristics.**
- * **Shipping around the corner or around the World – Foundation herd planning**

2004 Consignor List

Ass-Pirin Acres

Michael and Marshlynn Reed
4241 Vt. Rte 17W
Addison, VT 05491
802-759-2665
minidonk@together.net
asspirinacresdonkeys.com
Lots 16, 33, 53

Elms Farm Miniature Donkeys

Dowell and Martha Howard
5600 Bethany Road
Mason, OH 45040
513-398-3341
donkeys@donkeys.net
donkeys.net
Lots 1, 10, 22, 28, 42, 54

Feather Ridge Farm

Dennis Banning
521 Mill Street
Williamston, MI 48895
517-655-3873
Lots 6, 24, 37

Gardner's Miniature Donkeys

James (Doc) & Wilma Gardner
18600 Exotic Trl.
Kirksville, MO 63501
660-488-5553
docj@nemr.net
Lots 5, 23, 47

Half Ass Acres

Joe and Dayle Haworth
2539 Feed Mill Rd.
Chapel Hill, TN 37034
931-364-3715
donkeys@minidonks.com
minidonks.com
Lots 3, 41

Lamb's Exotic Ranch

Paul & Edna Lamb
1056 N 800 E Road
Bement, IL 61813
217-678-7241
Lots 15, 31, 49

Lazy N Ranch

Jon, Mary & Jay Nissen
1080 Hwy 17
Corwith, IA 50430
515-824-3603
nissens@lnminidonk.com
lnminidonk.com
Lot 46

Little Bit of Heaven

Jack and Sue Pentland
6480 W 900 N
Royal Center, IN 46978
574-643-9359
jack@cqc.com
Lots 13, 36

Long Run Farm

Betty and K.C. Stegemoller
3500 Utica Rd.
Lebanon, OH 45036
513-932-1601
longrunminidonks@aol.com
Lots 8, 35, 43

McRoberts Game Ranch

Jerry & Barb McRoberts
P.O. Box 55
Gurley, NE 69141
308-884-2371
jbmcrob@daltontel.net
mcrobertsgamefarm.com
Lots 4, 12, 20, 34, 45, 52

Merry-Go-Round Minis

Marlene Clark
14500 Van Syckle Rd.
Gregory, MI 48137
734-498-3590
grclark@direcway.com
Lots 9, 18, 48

2004 Consignor List

Oleo Acres

Jayne and Tom Fisher
8710 Hume Lever Rd SE
London, OH 43140
740-852-0349
oleoacres01@aol.com
oleo-acres.com
Lot 30

Perfection Miniature Donkeys

Val & Deone Townsend
RR1 Site 7 Comp 14
Sylvan Lake, AB T4S 1X6
CANADA
403-887-2285
lsangus@telusplanet.net
perfectionlamas_miniaturedonkeys.com
Lots 2, 14, 25, 32, 51

Ravenwood Farm

Jerry & Susie Patterson
6128 South 1100 West
Hartsville, IN 47244
812-546-6128
donkeys@hsonline.net
ravenwoodfarm.com
Lots 17, 39

Red Barn Miniatures

Glenda & Jackie Woods
528 River Rd
Church Hill, TN, 37642
423-357-3454
ggw528@yahoo.com
Lots 19, 40

The Red Gate

Scott & Theresa Ellinger
14677 Dutch Cross Rd
Centerburg, OH 43011
740-625-9092
theredgate@axom.com
theredgate.com
Lot 26

Southern Mountain Horse Co.

Bob & Julie Wagner
13550 Rainbow Lake Rd
Shade, OH 45776
740-696-1088
jwagner@smhc.com
Lots 7, 50

Sunset Acres Miniature Donkeys

Bob & Cindy Lowenstein
1103 E. Sunset
Grand Island, NE 68801
308-382-7474
sunset@minidonkeys.net
minidonkeys.net
Lots 11, 44

Willmann West Prairie Farm

Gene & Betty Willman
5455 West Prairie Drive
Belleville, IL 62220
618-235-0221
Lots 21, 38

Windcrest Acres

Ed and Linda Trimnell
4472 State Rte 133
Batavia, OH 45103
513-724-1111
trimnell@aol.com
windcrestacres.com
Lot 27

Wit's End Farm

Bob & Sandy Doris
7515 Pewitt Road
Franklin, TN 37064
615-799-1845
witsendfarm@mindspring.com
witsendfarmdonks.com
Lot 29

1 The Elms *Red Trillium*

Dark Sorrel Jennet, Birth Height 21.25"

Consignor: Elms Farm Miniature Donkeys, Aug 9, 2003, Reg # Pending

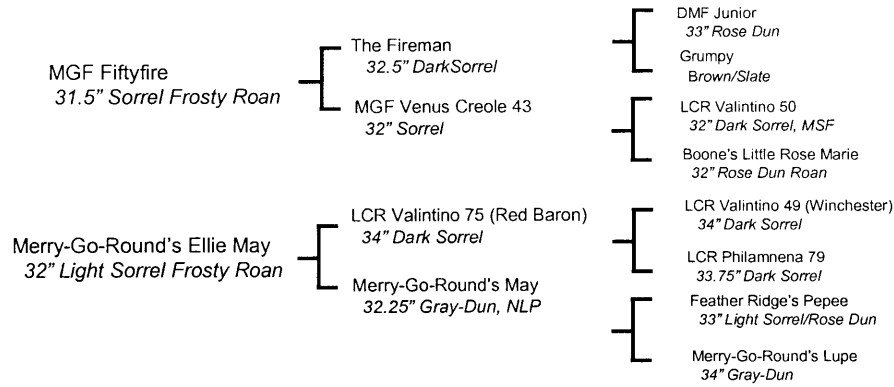

We wanted to kick off this year's sale with a bang, and what better way than to offer this beautiful small, correct, dark sorrel jennet, Red Trillium. FiftyFire crosses well with our Red Baron daughters, giving his presence and poise to his offspring. Red Trillium has good bone, a rounded hip, balance, and presence, combined with dark sorrel color. Red Trillium are very rare wildflowers, and you will not often have the chance to buy a jennet as rare and special as this Red Trillium!!!

2 Perfection's *Me Oh My*

Black Jennet, Birth Height 19"

Consignor: Perfection Miniature Donkeys, Sept. 3, 2003, Reg # Pending

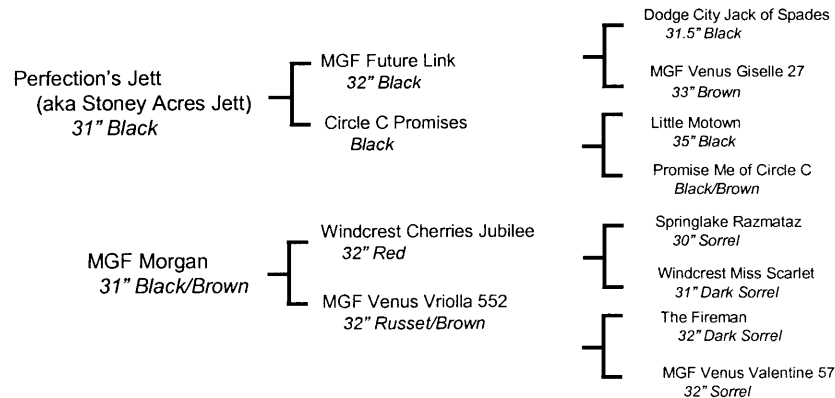

What a perfect blend...JETT crossed with the little Morgan. JETT has out-produced our wildest dreams. He marks his foals with great dish heads, stove pipe legs, wide chests and small stature. Me Oh My is just what I said when this little beauty hit the ground! What Me Oh My lacks for in size, she surely makes up for in attitude. This is a jennet that will stay small and is backed up by generations of small donkeys. Here is your chance to get a piece of the JETT legacy now. Don't Miss IT!

3 Half Ass Acres *American Beauty*

Dark Brown Jennet, Birth Height 22", 29" (June, 04)

Consignor: Half Ass Acres, Sept. 26, 2003, Reg # 36604, J110340

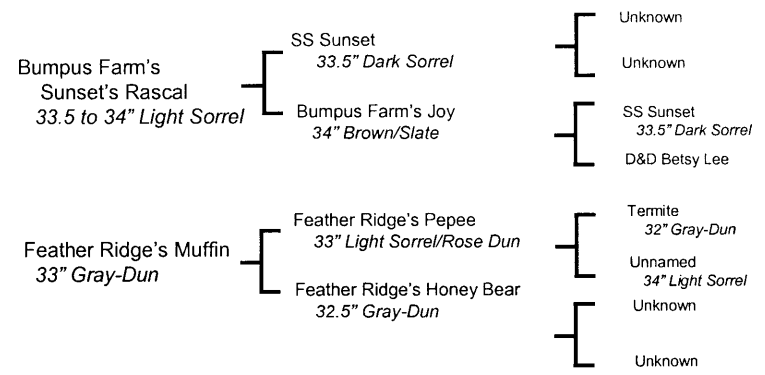

We wanted our very best to represent our farm in support of this sale. American Beauty is a gorgeous very dark brown and correct jennet. Both her sire and dam are under 30", and we expect her to stay just as small. She has a perfect bite and very correct conformation. She is very sweet and easy to handle too. Look no further than 'American Beauty' if you are looking for small, pretty, and correct to add to your breeding program.

4 MGF *Cherries Beau*

Sorrel Jack, 31"

Consignor: McRoberts Game Farm, July 4, 2001, Reg # 38414

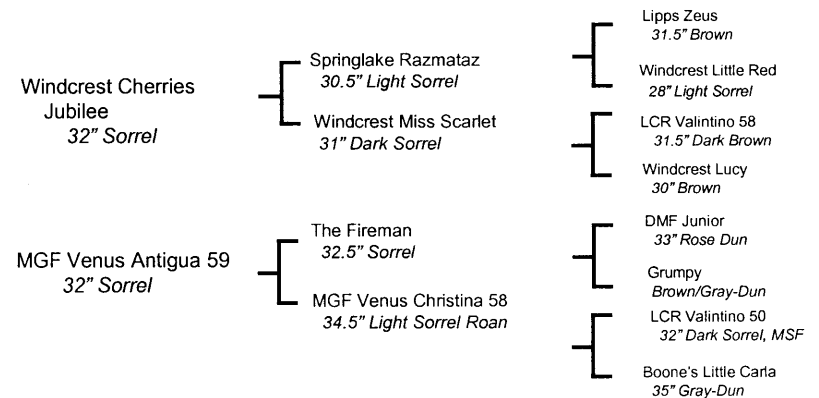

Meet Cherrie's Beau, a 31 inch, very correct, and friendly Fireman grandson. A wonderful little jack. Wide chest, good bone, and great depth of sorrel color in his pedigree. Beau will steal the hearts of your jennets and will do his part to produce good color to boot. Don't miss him!

5 Gardner's *La Cantera*

White, Brown, Gray Spot Jennet

Consignor: Gardner's Miniature Donkeys, Apr 2, 2003, Reg # Pending

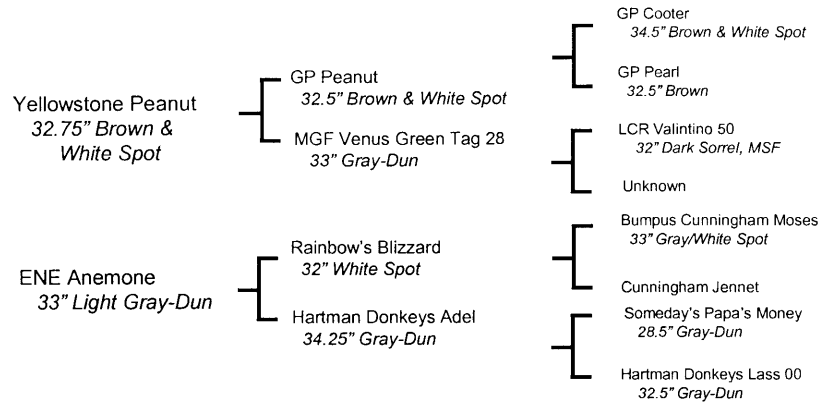

Consider La Cantera for your breeding program, Her mother is a Rainbow's Blizzard daughter and Dad is a GP Peanut son. Top that with unique color and conformation, it makes a nice combination. She will make a nice addition to your breeding herd.

6 Feather Ridge's *Bell*

Light Sorrel Jennet, 33.5" (Mar 04), Bred to Sorrel

Consignor: Feather Ridge Farm, Oct 6, 2001, Reg # Pending

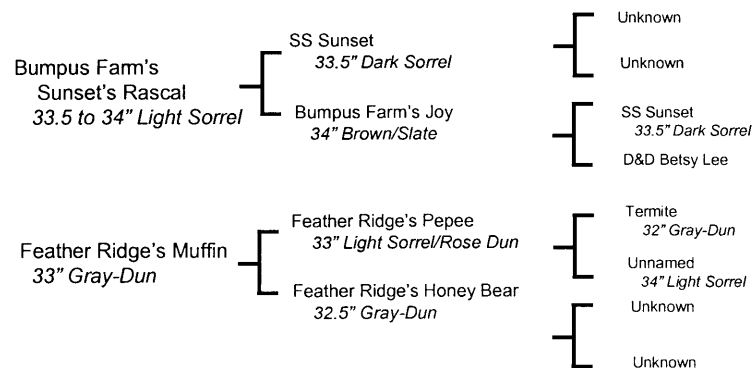

This donkey is a knockout, a real eye catcher. She has a real presence about her and is one of the best donkeys I've ever produced. She has the most beautiful head, and is so well conformed. She is bred to My World Parker (31" dark sorrel) for a spring 2005 foal. A wonderful outcross to the Valintino Line.

7 Southern Mountain Horse Company's *Bo*

Black, NLP Jack, 31.5"

Consignor: Southern Mtn Horse Company, May 10, 2000, Reg # Pending

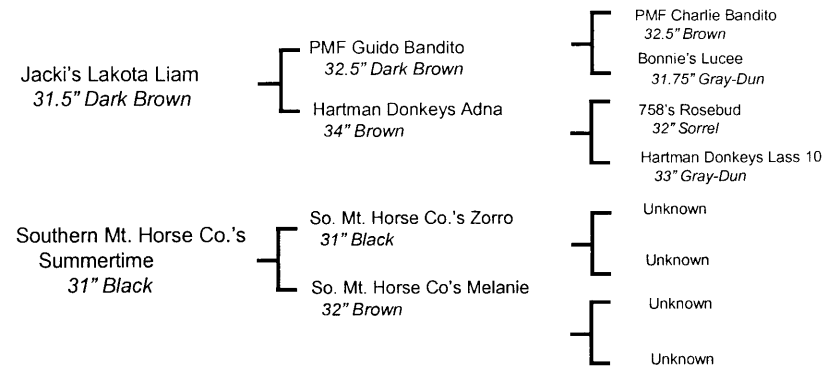

Bo's a very square jack, well put together and proven. Nice straight legs. He produces small dark babies and we guarantee him to be fertile. He is the type of build that produces those much sought after small, square and beautiful babies. His mother is 31" and black, and his father is 32" and dark brown. He traces his lineage back to Guido Bandito and Hartman's Rosebud.

8 Long Run *Practical Magic*

Gray Dun Jennet, 31" (Mar 2004)

Consignor: Long Run Farm, July 16, 2002, Reg # 35555

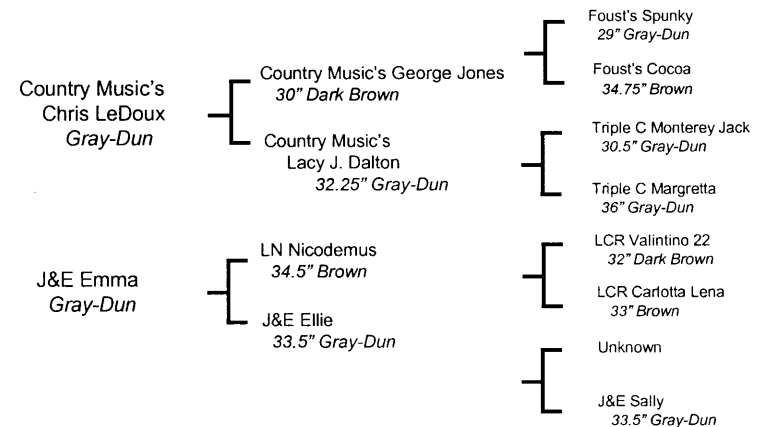

This is the one my husband hates to sell, so you know she's a super jennet. Her grandsires, Country Music's George Jones, and LN Nicodemus are both National Halter Champions. Her dam was shown very successfully as a two year old. Magic is round, firm and fully packed with the conformation and driving potential she was bred to achieve. She'll add class to any breeding program!

9

Merry-Go-Round's *Mr. Perlino*

White Blue Eyed Jack, 34.5"

Consignor: Merry-Go-Round Mini's, May 22, 1998, Reg # 22372

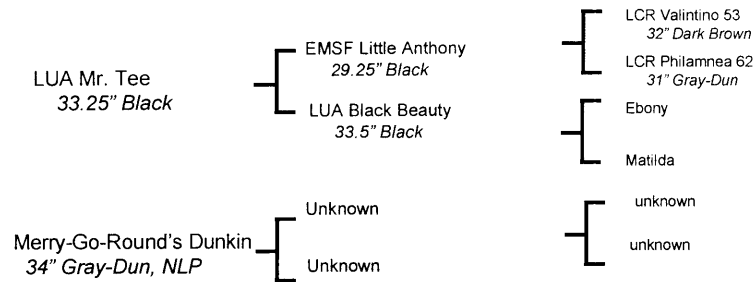

Here is an opportunity to add rare and unique genetics to your herd. Mr Perlino is stocky, correct Ivory/creme color, with a visible cross, ice blue eyes, and a sweet temperament. He is black based. He has produced 10 foals, 8 were jennets and 2 were jacks. 2 were Ivory with blue eyes like him, and 3 were black. His foals are well balanced with good bone. I have retained 6 of them and one of them was lot #4 "Porscha" in last year's sale. He is only being offered as he is so closely related to many of my jennets. Don't miss out on this one!

10

The Elms *She's Gloriass*

Dark Red Jennet, Birth Height 22"

Consignor: Elms Farm Miniature Donkeys, May 11, 2003, Reg # 37557

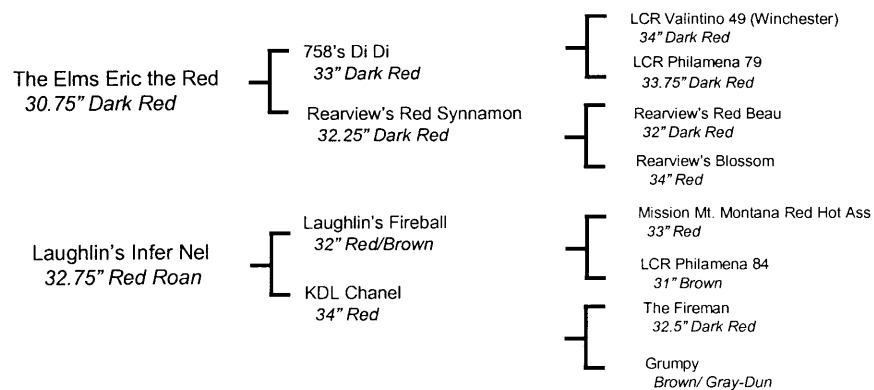

She is simply Glorious. Build, style, and superb presence make her an excellent show candidate. Glory walks into a space and owns it. Look at this pedigree, full of famous jacks and jennets, with tremendous depth of sorrel/ red color. This jennet will make you proud, and will be a superior asset to any breeding program.

11

Sunset Acres *Russian Blue*

Black, no cross jack, Birth Height 21", 29" (June 04)

Consignor: Sunset Acres, May 12, 2003, Reg # Pending

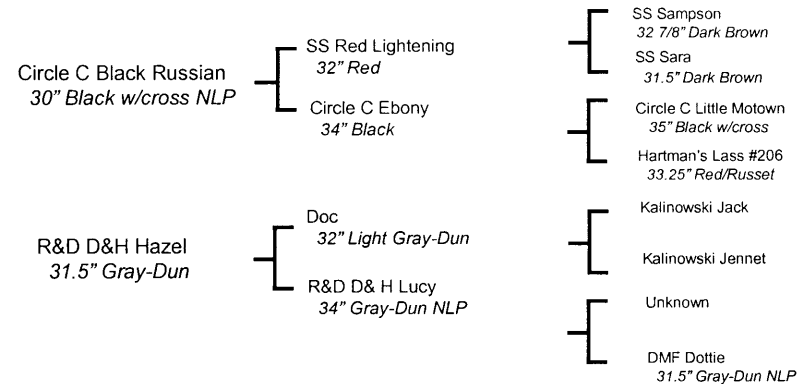

Lil' Blue is a small Black male out of a maternal line of donkeys that have produced volumes of True Blacks! And with Black Russian on the topside, you will have a double dose of Black genetics.

12

MGF *Black Helen*

Black, NLP Jennet

Consignor: McRoberts Game Farm, Sept 24, 2003, Reg # 38415

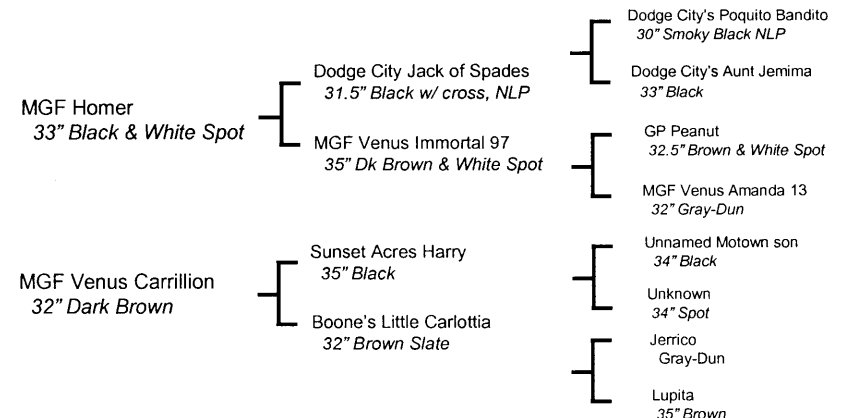

Black Helen is true black with a black nose. At 28", she is very small and correct! I consider Homer to be the best Jethro (Dodge City Jack of Spades) son we have raised.

13 Heavenly Snickers

Brown & White Spot Jack, 34" (Mar 2004) Sold With Cart & Harness!!
Consignor: Little Bit of Heaven, Apr 29, 2002, Reg # 34604, ACOSA SA 1824

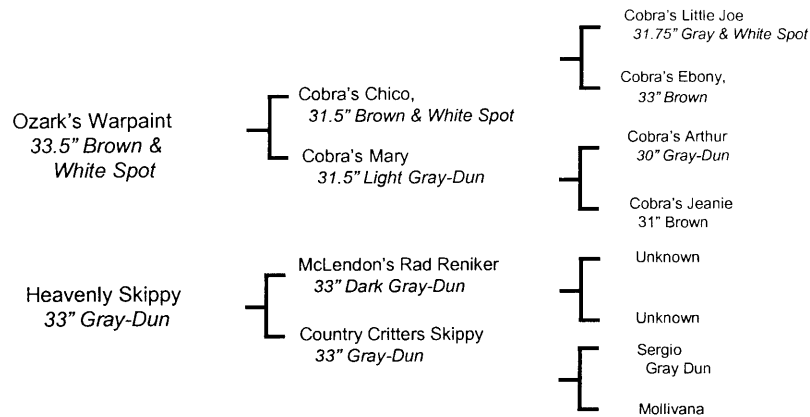

Heavenly Snickers is a real eye catcher. He has a lot of color and a beautiful personality. He has bred three of our jennets this spring and is a very gentle breeder. Snickers is also one of our show donkeys. He is being trained to drive. He is going to make a great performance donkey, and he has a great attitude. He is being sold with the cart and harness.

14 Perfection's Blushes X'Treme

Light Sorrel Jennet
Consignor: Perfection Miniature Donkeys, July 23, 2003, Reg # Pending

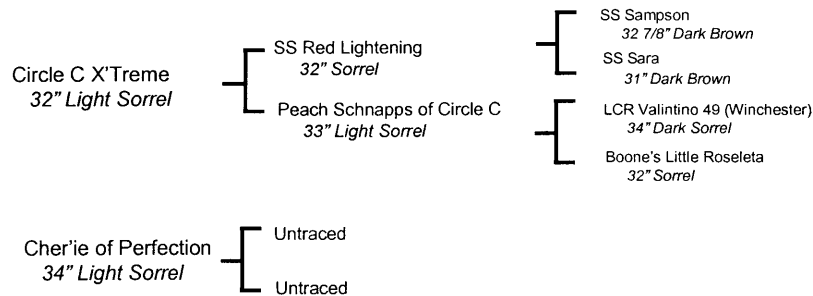

Like the color of a fine blush Zinfandel, Blush matures more beautifully everyday. She is a full sister to Champion AMDC Futurity jack Renegade. X'Treme has an impressive show record; World Champion Jack ('98 Calgary Stampede), Champion Jack '99 Mini Donkey Extravaganza, 2000 Maturity Champion Jack, Reserve Champion Jack NA Miniature Donkey Show & 3rd mature jack at the 2002 NMDA Shelbyville Show. Cher'ie, our "Quarter Horse Jen", is a great show jennet as well, having won her class 2x at the World Show, Champion Jennet at the Miniature Donkey Extravaganza, and Champion Maturity Jennet. Blush is the only X'Treme daughter we will be offering for sale this year, they are as rare as hen's teeth. Grab on to this little beauty and watch as she blossoms into a fine vintage.

15 Coffman's Danny de Valintino

Dark Brown Jack, 31.5"
Consignor: Lamb's Exotic Ranch, Apr 15, 1989, Reg # 10248

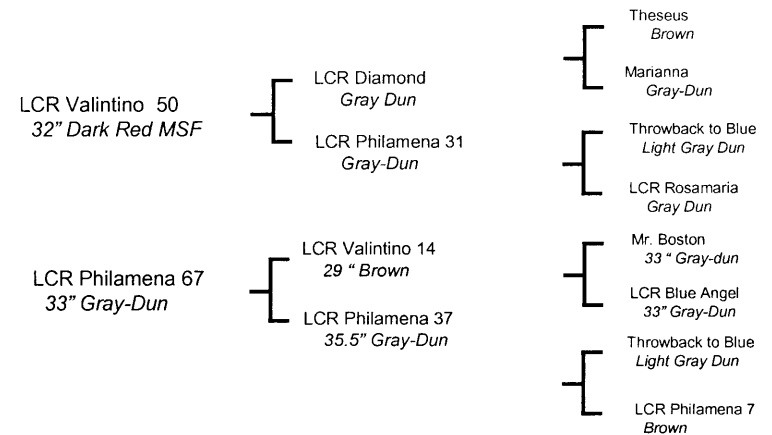

A stylish brown jack, has a neat small head, straight legs, correct bite, great body conformation, and the best of dispositions. He is great to pasture breed with as he never bothers the foals and gets the job done 98% of the time on the first heat period. A great breeding jack.

16 Shawmar's Revlon

Grey-Dun Jennet, 32.5", Bred to Black
Consignor: Ass-Pirin Acres, Aug 8, 2000, Reg # CDJE 3398

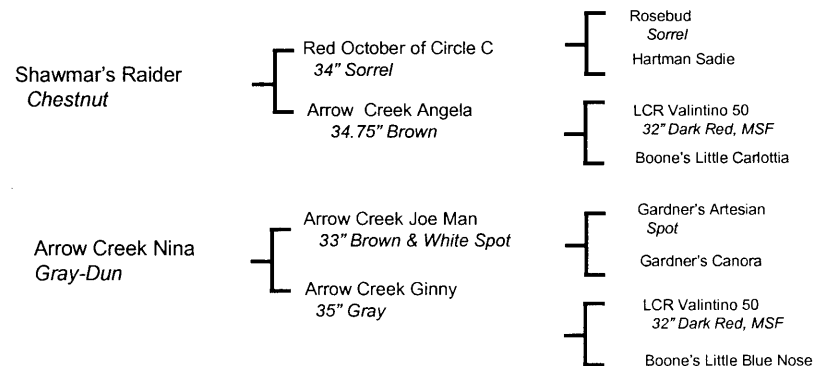

Revlon is a drafty, well boned donkey with a loving disposition. Her pedigree includes Valintino 50th, Circle C Red October and Boone's Farm's jennets. Revlon will be in foal by sale time to Arrow Creek's Keno, a black with cross, drafty 32" jack sired by Houdini. Even though Revlon is gray dun herself, she has the potential to produce sorrel or darks. With her background, she would work well in anyone's breeding program.

17

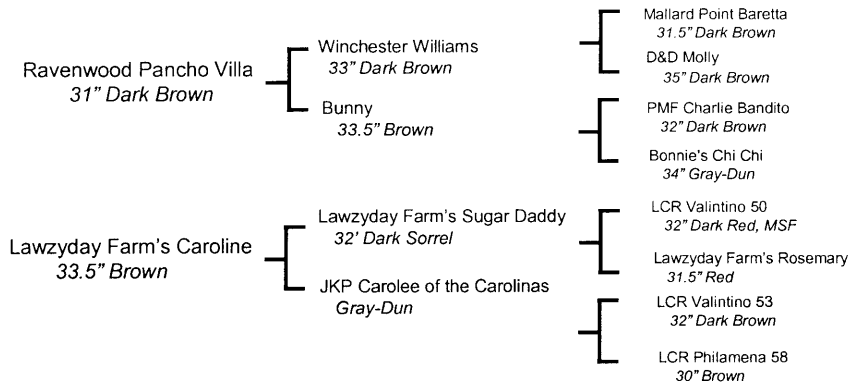
Ravenwood Spice**Dark Brown Jennet, 32" (Mar 2004)****Consignor: Ravenwood Farm, June 7, 2002, Reg # 33618**

Ravenwood Spice is a Blue Ribbon winning 32", 2 year old daughter of Lawzyday Farm's Caroline. Valintino 50, Theseus, Throwback to Blue are just a few of the well-known names in Caroline's pedigree. With an ancestry of dark sorrel and black/brown, Spice is dark chocolate with deep red undertones. Shown as a yearling, her outstanding conformation with excellent proportion, a feminine head with large expressive eyes, level top line, deep hindquarter, clean legs and fluid movement caught the judge's attention. This little girl has a sparkling personality.

18

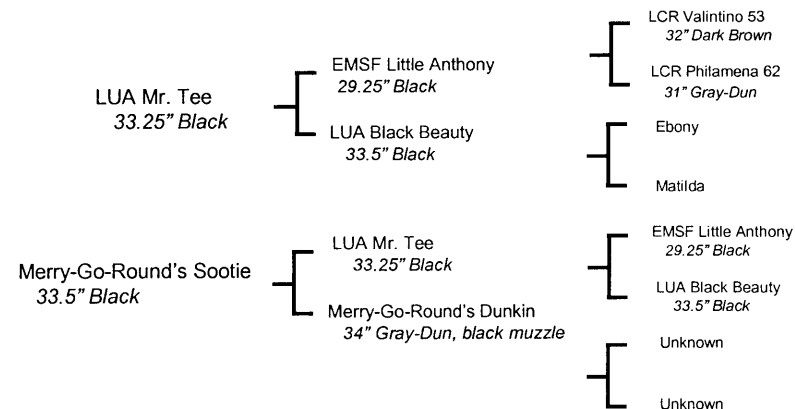
Merry-Go-Round's Morticia**Black, no cross Jennet, 35.5", Bred to Black****Consignor: Merry-Go-Round's Mini's, June 27, 2001, Reg # 31075**

Want black? This gal is ebony black with light points and no visible cross. She is out of my best black jenny "Sootie", 33" who is Mr Perlino's FULL sister. (Ivory gene?). Morticia is 3 years old. She is offered bred for Spring 05 with her first foal, to my newest herdsire, Braying Pines BJ ZZ Topp, black, drafty, light points with no cross, 32", and the added appeal of some very different black genetics that will enhance your black breeding program.

19

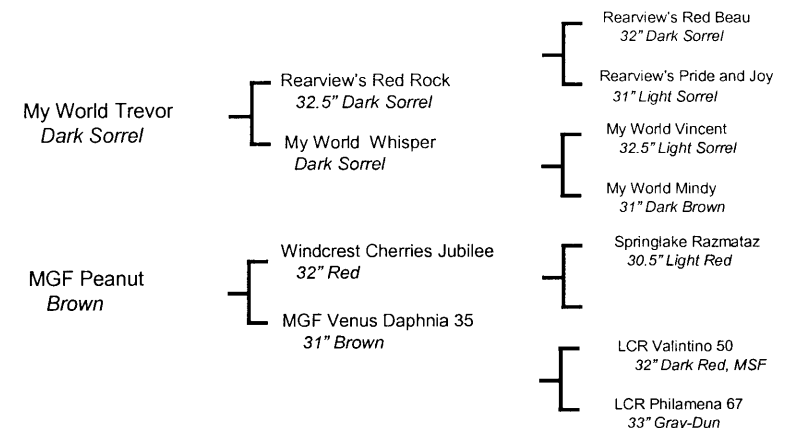
R.B.M.'s Stormer**Brown Jennet, Birth Height 20", 24" (Mar 2004)****Consignor: Red Barn Miniatures, Aug 30, 2003, Reg # Pending**

Stormer - We think she should be brown/red (Hard to tell). She has unique stripes (black) around her legs. She will be small and very compact. The best natured, sweetest baby we have had.

20

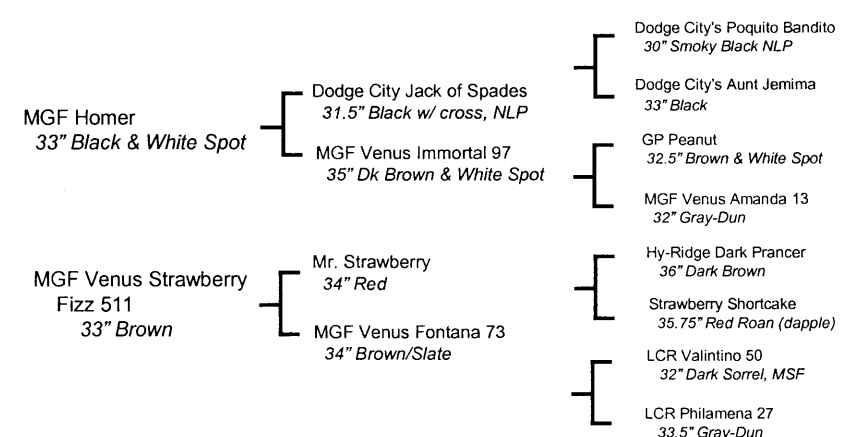
MGF Chocolate Topping**Brown & White Spot Jennet****Consignor: McRoberts Game Farm, June 24, 2003, Reg # 38417**

Chocolate Topping is 31", very feminine and nice. Homer is the best Jack of Spades son I have raised. This jennet has the Jethro (Jack of Spades) great build expected, with straight legs and good bone

21

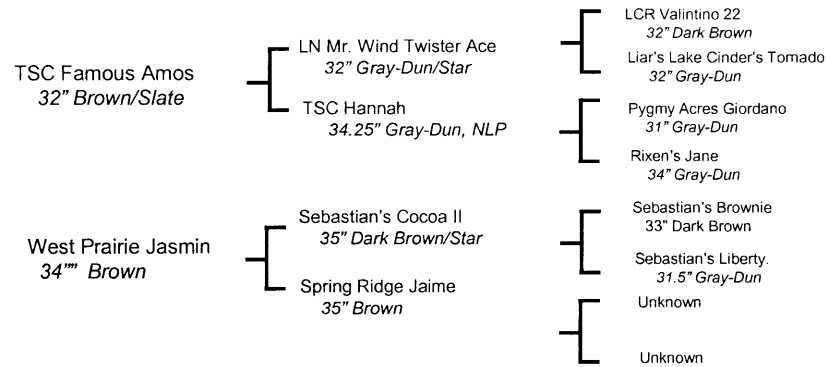
West Prairie *Leane***Brown Jennet, Birth Height 22", 31" (Mar 2004)****Consignor: Willmann's West Prairie Farm, Aug 18, 2001, Reg # 37827**

Leane is a very nice little brown Jenny with dark cross, good conformation, very gentle. She has dark genes and when bred with black or dark brown jack will most likely have a black or very dark brown foal. She is small, 31" on 3/30/04, was 22" tall at birth. She will be three years old Aug 18, 2004. She has brown and dark brown genes on both sides of her parents, out of TSC Famous Amos.

22

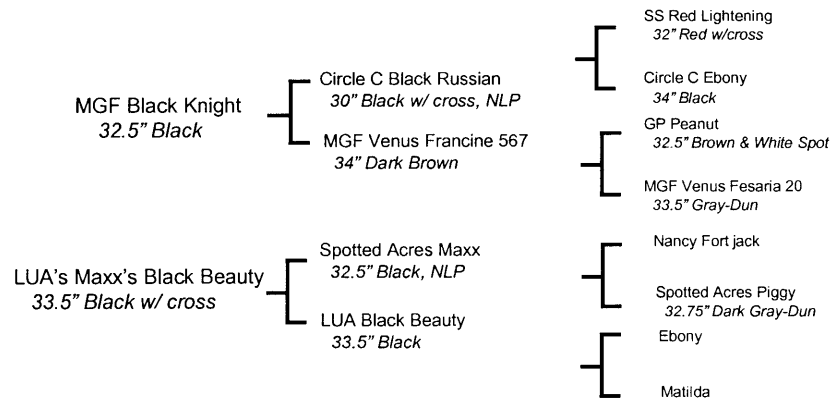
The Elms *Perfect Black***Black, No cross, NLP Jennet, Birth Height 22"****Consignor: Elms Farm Miniature Donkeys, July 29, 2003, Reg # Pending**

Perfectly Black!!! Perfect in build, a very, very nice jennet. Lustrous true black color, with no white anywhere. All topped off with a sweet personality. We are thrilled with Black Knight's foals, and she is the best we have had. It is very hard for us to part with "PB" but we know she will be just "Perfect" for your show and breeding herd!

23

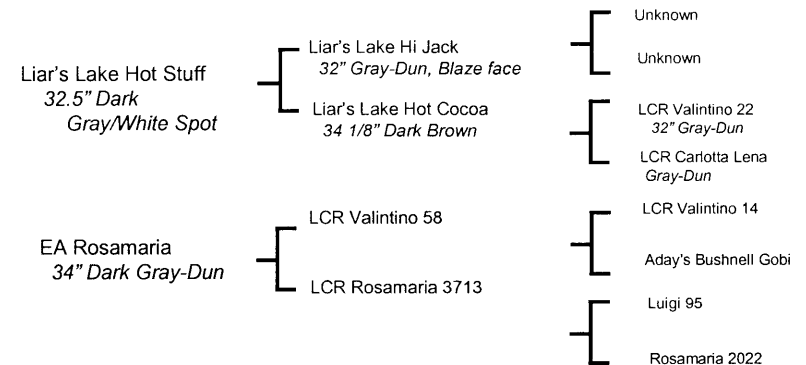
Gardner's *Henrietta M.***White, Brown, & Gray Spot Jennet****Consignor: Gardner's Miniature Donkeys, Aug 29, 2003, Reg # Pending**

Henrietta's of Valintino heritage. Birth height was low and she has stayed small. She has good color, size and disposition. Very small and petite.

24

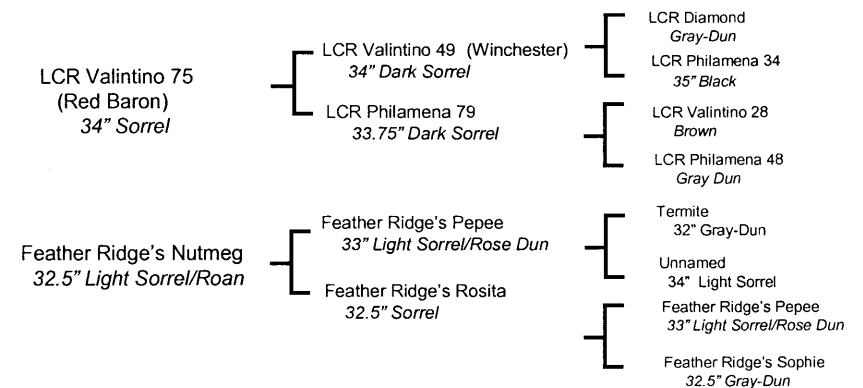
Feather Ridge's *Harvest Moon & Foal***Dark Sorrel Jennet, 34", Bred to Sorrel****Consignor: Feather Ridge Farm, Jun 24, 1997, Reg # 21056**

Harvest Moon is a well built Red Baron (Valintino 75) daughter. She is a good sound jenny and has had 3 jennets out of different sires each time. She is bred to My World Parker (31" dark sorrel) for a June 2004 baby. She would make a wonderful addition to anyone's herd. I truly think some of the best dark red sorrel color has come out of the dark red Valintino line.

25 Perfection's *Nikita*

Grey Jennet, Bred to Black

Consignor: Perfection Miniature Donkeys, May 17, 2001, Reg # Pending

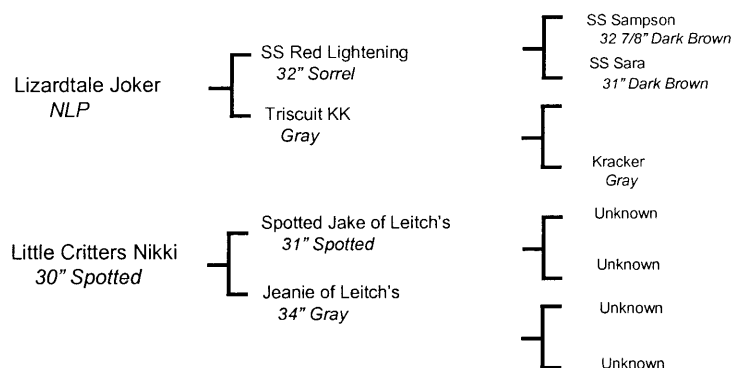

Imagine the possibilities a jennet with the stature of Nikita, carrying spotted genetics, bred to JETT...I am thinking black and white spots could be a good possibility. Nikita's dam is the smallest stockiest spotted jennet that we have ever seen, her sire is a black nosed son of the great Red Lightening. Great things will come from this little jennet. This is your last opportunity to get a piece of JETT this year, so don't pass it up!

26 The Red Gate's *Velvet*

Dark Brown, NLP Jennet, 34"

Consignor: The Red Gate, Oct. 2, 2001, Reg # 34078

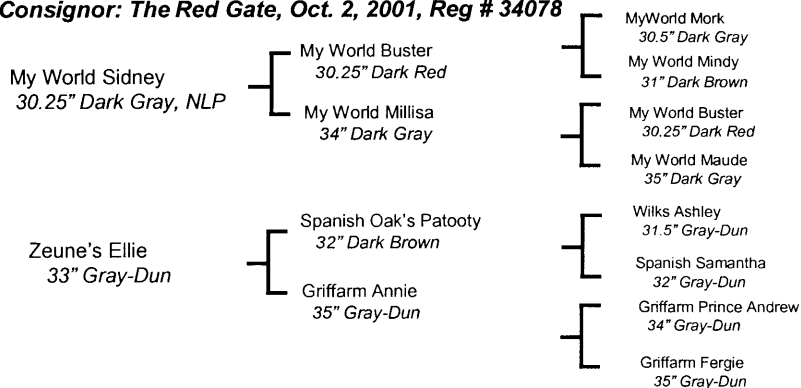

Velvet is a beautifully built, dark jennet with a strong show presence. She is registered as a dark brown, but can be more accurately described as smoky black. Her sire, MW Sidney, is a very stocky & correct Buster son who produces strong color, having sired sorrel, jet black, and several smoky black, black nosed foals. Velvet has proven herself in the show ring; 4th in 2 year old jennets at 2003 Cheers for Ears (20 entries) & NMDA Reserve Champion Jennet, 2003 Ohio State Fair. Take this opportunity to add this quality, coming 3 year old, with possibly a new black bloodline, to your breeding program! She's hard to part with!

27 MGF *Venus X-Phile 600*

Black with Cross, NLP Jennet, 34", Bred to Dark Brown NLP

Consignor: Windcrest Acres, Oct. 7, 1996, Reg # 22876

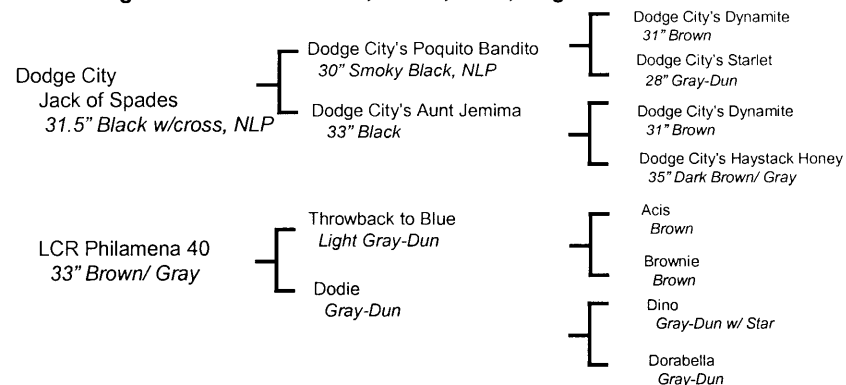

If you want Black, great conformation, bred to a beautiful black jack (Sunset Acres Speedway Racer for 2005), and all tied up in a sweet, easy to handle disposition, here she is. X-Phile has a pedigree that is tops, and she's a joy to be around. She's half sister to our Windcrest Herd Sire, Merlin. Howard's asked us for something special, so we decided to do just that and offer X-Phile. Easter Mist, X-Phile's yearling spotted daughter by a white jack, is being retained in our herd. Her babies are gorgeous- whoever gets X-Phile will be getting a winner!!!

28 The Elms *Vienna Serenade*

Very Dark Brown Jennet, Birth Height 22"

Consignor: Elms Farm Miniature Donkeys, Aug 15, 2003, Reg # 37558

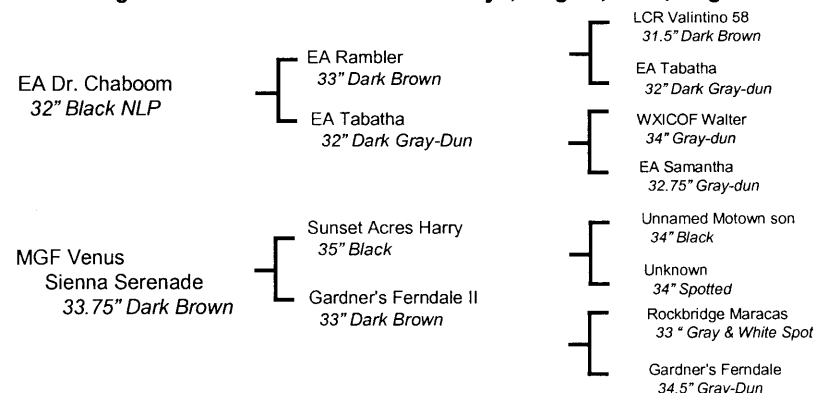

Vienna Serenade is a Hot Chocolate! Not quite black, but she carries the genetics to produce it. This is our first foal by Chaboom, our black, NLP herdsire, to be offered for public sale, and we think you will like what you see. She has balanced conformation, an easy movement, and is just beautiful to look at. This is a special jennet for your dark breeding program, plan to take her home with you!!

29

Pine Grove Farm's *Lollipop & Wit's End Ahhh Cappella*

Dark Brown Jennet, 33.25" Apr 10, 1997, Reg # 28441
 Black/Brown Jennet Foal, May 1, 2004, Birth Height 20"
 Consignor: Wit's End Farm, Foal Reg #Pending

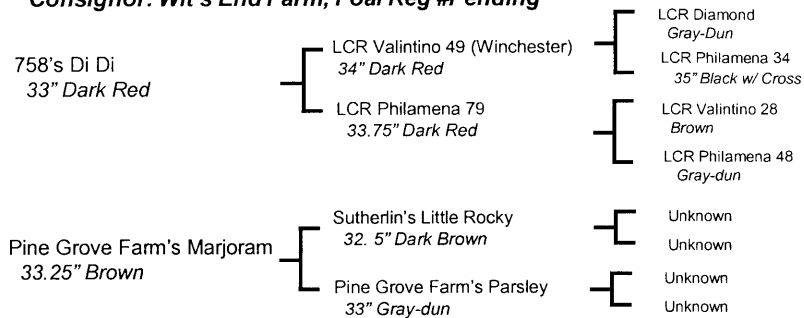

Here's a great 2 in 1 package. Lollipop, a great jennet who produces fantastic foals, and AHH-Cappella, sired by our Sunset Acres Speedway Racer. Cappella is a real 'eye catcher', with excellent conformation, straight legs, perfect bite, and a great sorrel & black/brown pedigree. Cappella has that lovable disposition with personality+ that we all like in our foals. Lollipop has had a dark brown jack (now a herd sire), and has the capability to produce both sorrel or browns. She is open ready to breed to your jack. Don't go home without this pair!

30

TomAsses *Nova Star*

Dark Sorrel With Star Jennet, Birth Height 22"
 Consignor: Oleo Acres, Nov 17, 2002, Reg # 34932

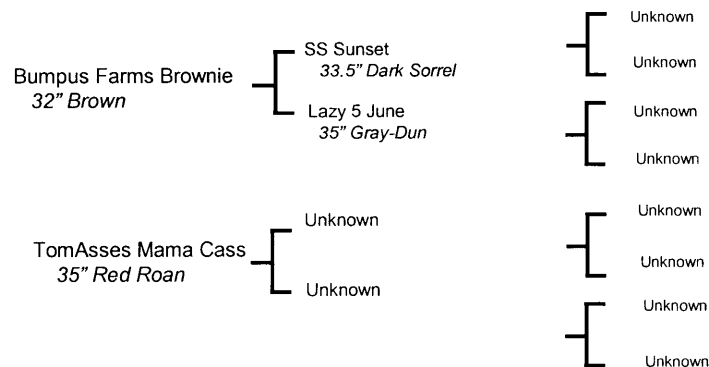

Nova Star is a beautiful dark sorrel with a white star on her forehead. In July 2003, at the Madison County Fair, she was a 4H project for a first time 4Her and placed 5th her very first time in a show arena. 2 weeks later she placed 1st in 2003 Foal Class, Preble County Fair, Eaton, OH. She has a wonderful disposition, eager to please and is loaded with love. Several shows scheduled for 2004.

31

Pygmy Acres *Diamiss*

Dark Brown Jennet, 33.5", Bred to Black
 Consignor: Lamb's Exotic Ranch, Mar. 18, 1995, Reg # 18986

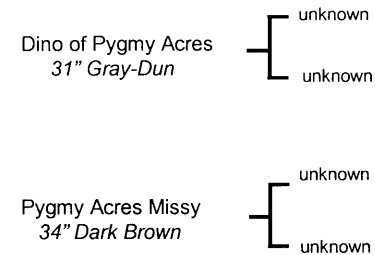

Here is a jennet that's at her peak in producing top quality foals. Diamiss is an excellent breeding jenny, with a nice neat head, good bite, straight legs, good body conformation, and wonderful disposition plus easy breeder. Always produces a real nice dark brown foal, the kind you like to have in your herd. She is bred to Merlin, a 29.5 in black jack, a grandson of Top Gun.

32

Perfection's *Red Sedona*

Sorrel Jennet, Birth Height 22"
 Consignor: Perfection Miniature Donkeys, Sept 3, 2003, Reg # Pending

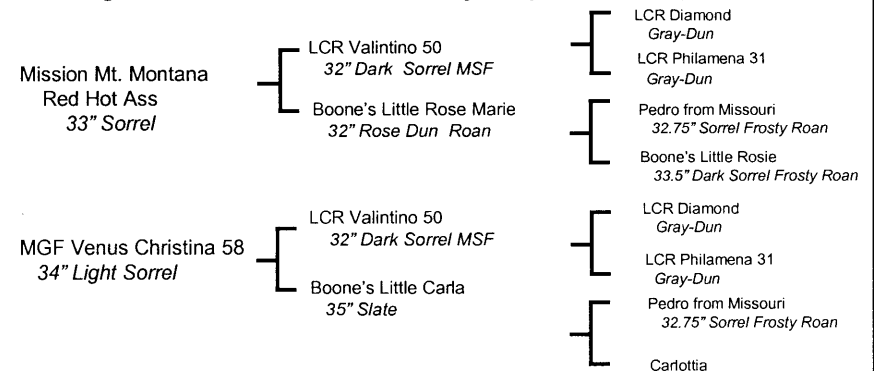

An exotic Red like the mountains around Phoenix. Sedona is a full sister to one of the high selling jennets Redda Lynn at last year's NASS. If you are looking for a jennet to show, this is the girl for you. These Red Hot daughters are born to show! Sedona's color runs deep, she will be a great addition to anyone wanting to seriously breed sorrel. This may well be your last opportunity to obtain a Red Hot daughter, as we don't intend on releasing any more for sale. These daughters are proving to be invaluable in our breeding program. So don't miss this one last chance!

33

Blue Chip *Kassandra*

Dark Brown Jennet, 31.75" Reg, 33.75" Actual, Bred to Sorrel
 Consignor: Ass-Pirin Acres, June 15, 1995, Reg # 22390

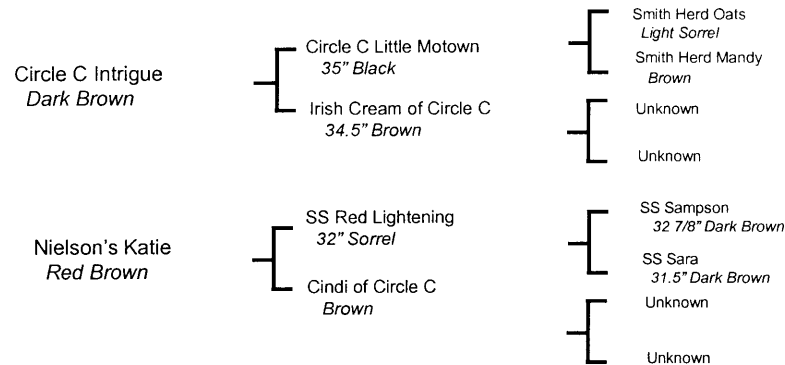

Kassandra is a well conformed brood jennet. She has given us very dark foals with balance and good bone. This jennet can be bred sorrel or black. We have chosen Ass-Pirin Acres Jam B Lya to sire her next foal. He is 30" sorrel. Nice package here with good breeding.

34

MGF *Berry Beret*

Brown & White Spot Jennet

Consignor: McRoberts Game Farm, Oct 1, 2003, Reg # 38419

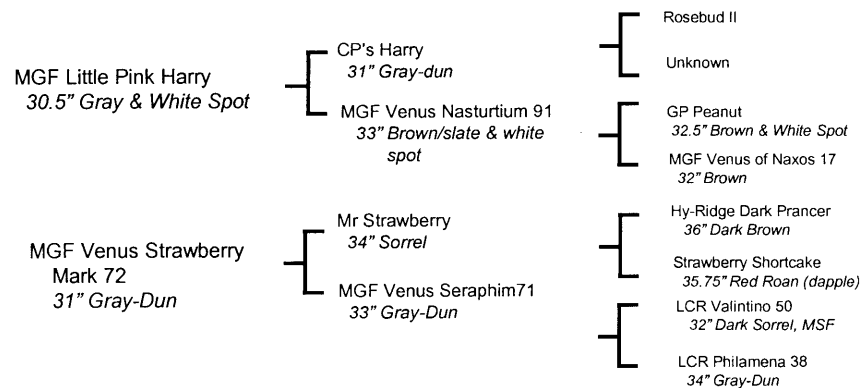

Berry Beret measures at 29" and is a very stocky - very nice female

35

Long Run *Almost Famous*

Gray-Dun Jennet, 31" (Mar 2004)

Consignor: Long Run Farm, Aug 8, 2002, Reg # 35556

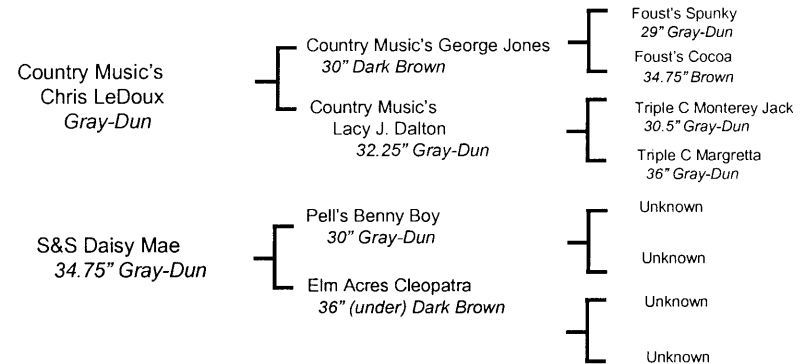

A granddaughter of National Champion George Jones and Pell's Benny Boy. Famous has what it takes to excel. She is balanced and correct thru and thru. You can be proud to lead a jennet this well built into the show ring. And she should put some super correct foals on the ground with the right jack. If you're trying to produce foals that are the "complete package" this jennet could get you to your goal a lot faster.

36

Heavenly *Petula* & Foal

Dark Brown Jennet, 34"

Consignor: Little Bit of Heaven, Jun 20, 1999, Reg # 25610

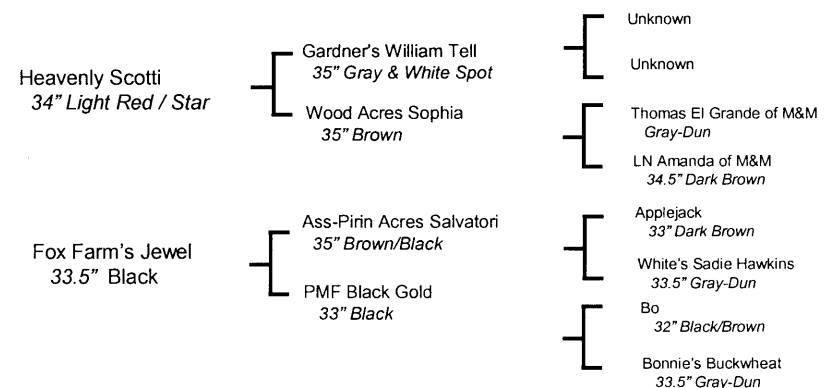

Heavenly Petula is an ex-show jennet that did very well in the show ring. Her personality is exceptional. She loves her daily rubs and hugs. She is bred to LN Dark Jo, a 32" Black/Brown jack and should have a colt by her side. She is due the last of June.

37

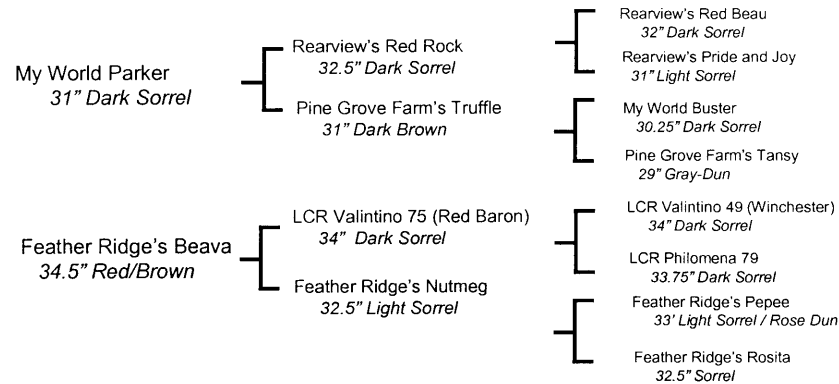
Feather Ridge's *Copper Penny***Dark Sorrel Jennet, 31.5" (Mar 2004)****Consignor: Feather Ridge Farm, May 31, 2003, Reg Pending**

This jennet has good bone and substance – a very drafty, dark sorrel donkey with very long ears, and a real lover. This gal really fits the bill. A My World Parker (31" dark sorrel) daughter and her mother is a Red Baron daughter. Would keep her in my breeding program if I could.

38

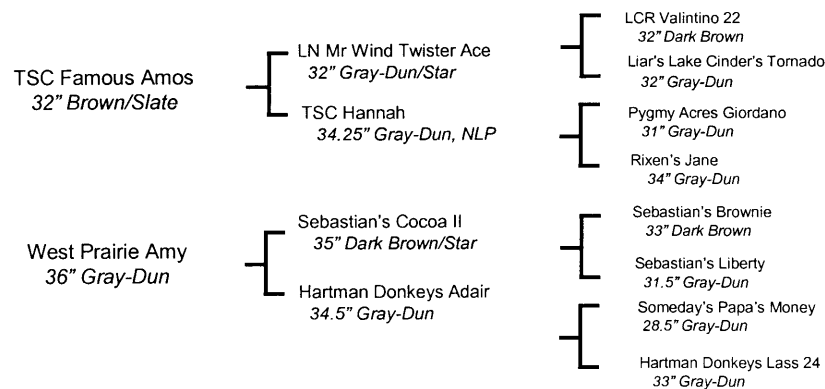
West Prairie *Amber***Gray Dun Jennet, 31" (Mar 2004)****Consignor: Willmann West Prairie Farm, Sept 22, 2001, Reg # 37826**

Amber is a nice little gray-dun jennet, great conformation, straight legs with black cross, out of TSC Famous Amos. She has dark genes from her father and grandfather's side, 22" at birth. She will be three years old 9/22/04, ready to breed, 31" at 3/30/04

39

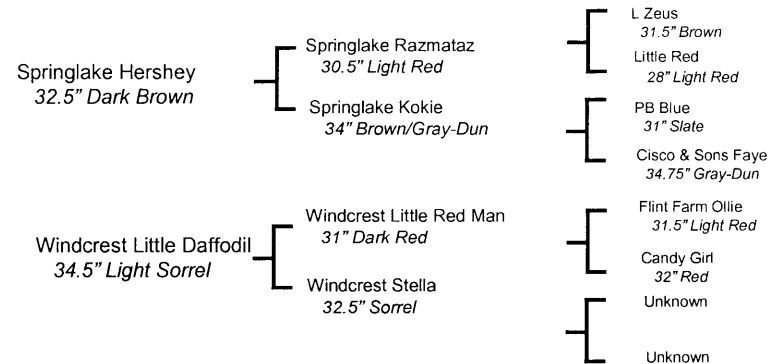
Ravenwood *Misty Dawn***Dark Red/Brown Jennet, 32.5" (Mar 2004)****Consignor: Ravenwood Farm, May 5, 2002, Reg # 33617**

Ravenwood Misty Dawn is a 32.5" 2 year old daughter of light pink sorrel Windcrest Little Daffodil (31" Windcrest Little Red Man and 32.5" Windcrest Stella) sired by 32.5" dark brown Springlake Hershey (30.5" Springlake Razmataz and Springlake Kokie). With an ancestry of light red, dark red, sorrel, and dark brown, Misty Dawn is a dark red brown. She has her dam's beautiful baby doll head, a level topline, deep hindquarter and clean legs. Dawn has a cuddly personality

40

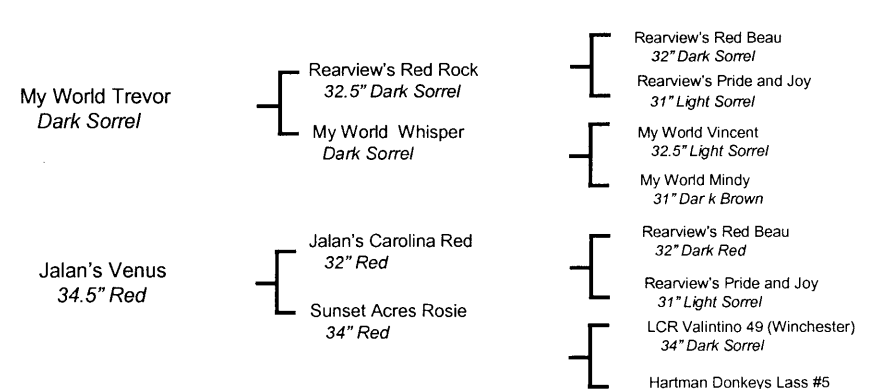
R.B.M.'s *Maggie***Sorrel with blaze Jennet, Birth Height 22", 26" (Mar 2004)****Consignor: Red Barn Miniatures, Aug 19, 2003, Reg # Pending**

Maggie — We think she should be medium to dark red. She has a beautiful white blaze in her forehead. Conformation is very correct. Elegant!

41 *Half Ass Acres Bedazzled*

Very Dark Brown, NLP Jennet, Birth Height 20.25", 28.75" (June 04)
Consignor: Half Ass Acres, May 17, 2003, Reg # 35528, J060320

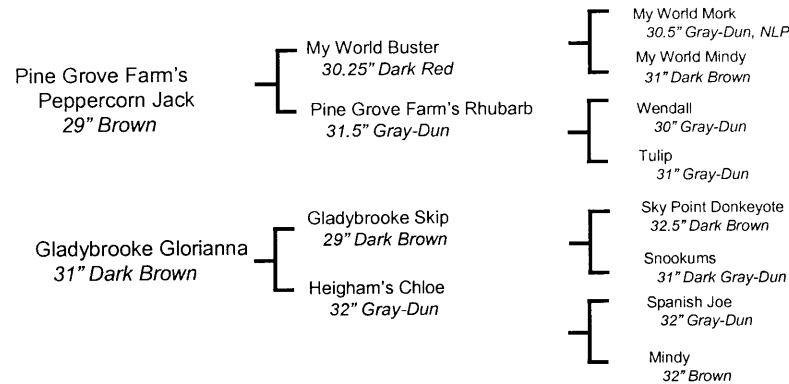

Bee is a tiny dark brown jennet with no light points. She is correct, stocky, wide and square with straight legs and a perfect bite. She has the perfect personality to go with her looks too. She never meets a stranger. We wanted to support this sale with our very best stock and that is what we are offering here today. Bedazzled is truly one of a kind. Don't let her get away as you may never be so lucky again!

42 *The Elms Red Alyssum*

Dark Red Jennet, Birth Height 21"
Consignor: Elms Farm Miniature Donkeys, Sept 30, 2003, Reg # Pending

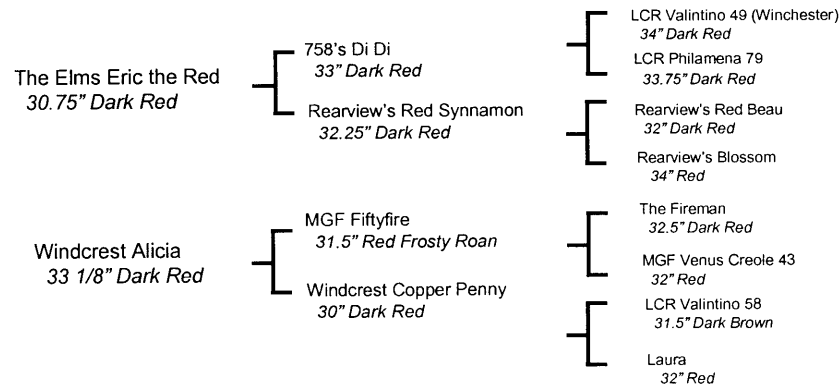

A dainty red flower of a donkey, Alyssum is staying small, and displays the excellent build we expected of this breeding. Her sire, Eric the Red, is stamping foals with excellent conformation and rich color. Her dam, Alicia, is a spectacular, very correct, and very dark red daughter of Fiftyfire. This jennet represents the best of our breeding program. Take her home and get a thrill watching her mature!!

43 *Long Run As Good As It Gets*

Gray Dun Jennet, 31" (Mar 2004)
Consignor: Long Run Farm, Aug 26, 2002, Reg # 35558

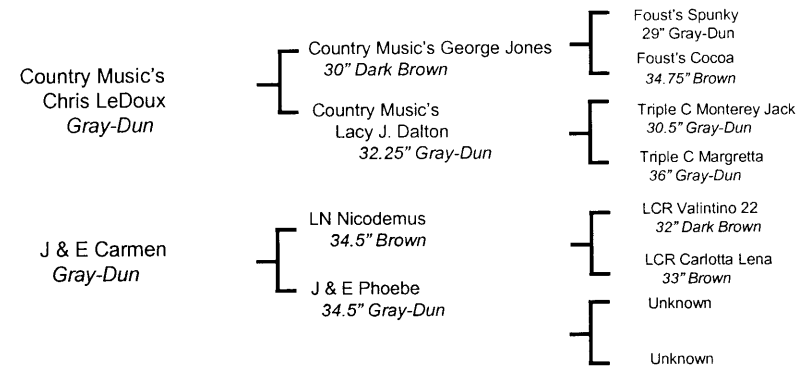

Type, balance and conformation. That's what the judge looks for and this jennet has it all. Her grandsires, Country Music's George Jones and LN Nicodemus were both national champions. Her dam, J&E Phoebe is a full sister to the 1997 National Reserve Champion Jennet. Goody can add substance, pedigree and performance ability to your herd or show string. Her willing disposition makes her a pleasure to be around.

44 *Sunset Acres Shadow Mist*

Black Jennet, Birth Height 21", 28.5" (June 04)
Consignor: Sunset Acres, Aug 8, 2003, Reg # Pending

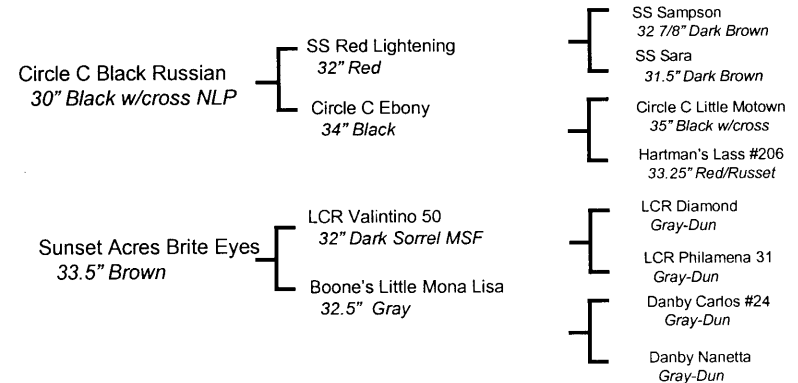

Here is a nice and small Black Russian daughter with light points... We think she is an excellent female from our breeding program that will do well in the Show ring and as a brood jenny.

45

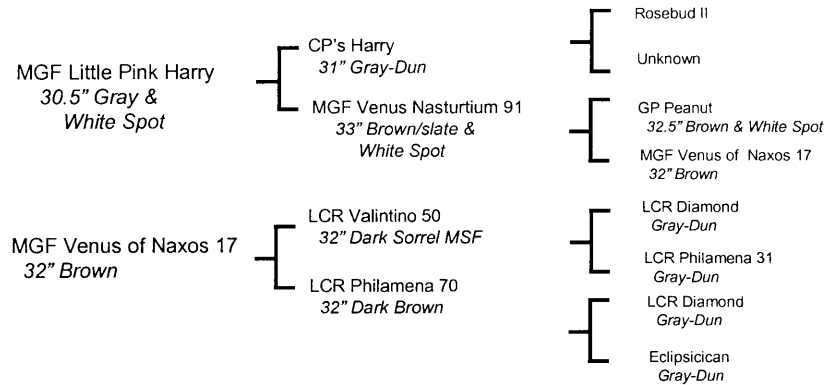
MGF Porcelain Doll**Frosted Spotted White Jennet****Consignor: McRoberts Game Farm, Oct 19, 2003, Reg # 38416**

Porcelain Doll is very tiny and typy! She is a doll!!! She measures 28" - very correct... just very nice!. She is friendly, loves brushing. The Registry says possible brown or red base, could be she hides red and white spots under her foal coat.

46

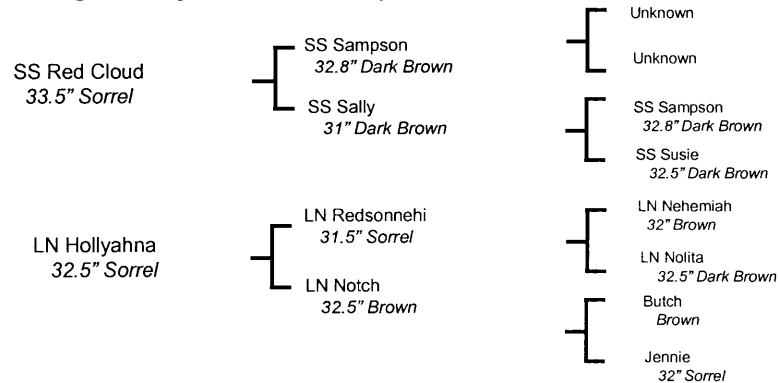
LN Cloud Nine & LN Red Sky**Matched Red Sorrel Driving Team, Geldings****Consignor: Lazy N Ranch, Red Sky 5/27/03, Cloud Nine 1/1/02, Reg Pending**

Here is a team of fancy, rich sorrel, well-matched full brothers, that will be hard to tell apart, especially as they mature. The dam and sire are of good quality and especially nice disposition, which these two sons have also inherited. They are well started, and started right, in leading over obstacles and being a driving team as well. Over the years we have had much enjoyment training & driving (singles to as many as 24 up) of geldings. This sharp looking pair will surely provide you with many fun days and years to come, whether you show, or just enjoy them at home.

47

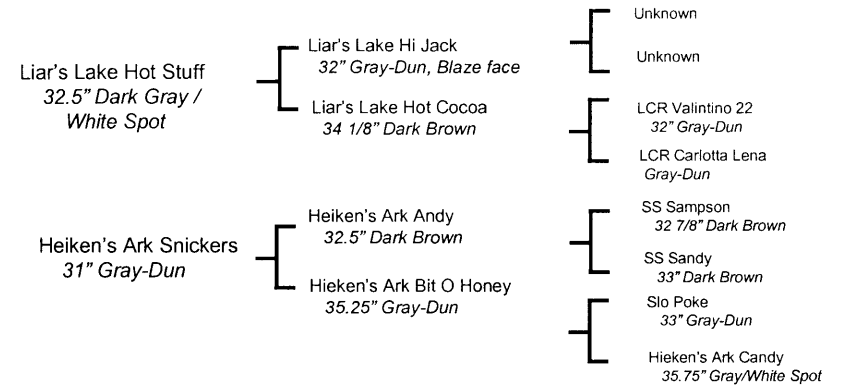
Gardner's Madeira B.**White, Brown, Gray Spot Jennet****Consignor: Gardner's Miniature Donkeys, Aug 12, 2003, Reg # Pending**

She has an interesting color pattern on a very proper frame. It makes a pretty picture. She is a people's donkey.

48

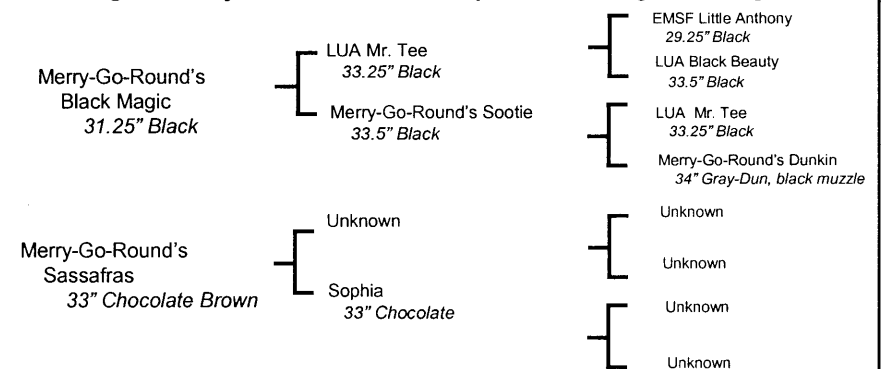
Merry-Go-Round's Bewitched**Black with cross Jennet, 33.5" (May 2004)****Consignor: Merry-Go-Round's Mini's, Apr 29, 2003, Reg # Pending**

15 months at sale time, Bewitched is a black with visible cross. She is correct and balanced and currently measures 33.5" tall. She is out of one of my dark foundation jennies Sassafras, who has given me many nice foals, including Merry-Go-Round's Delilah, lot #23 in last years sale. Bewitched's sire, Merry-Go-Round's Black Magic, 31.25", out of my best black jenny Sootie, is ebony black with light points and no cross. He is featured in the Herdsire Showcase. Here is a great chance to add to or start your black based herd. (Possible Ivory gene carrier? Sootie and Mr Perlino are FULL siblings)

49

Sunset Acres Eileen

Light Rose Dun Jennet, 34" Bred to Sorrel

Consignor: Lamb's Exotic Ranch, Mar. 1, 1994, Reg # 16558

Hedrick Jack
Spotted

— [unknown
unknown

Hendrick Jenny
Brown

— [unknown
unknown

A great breeding jennet, bred to a good red sorrel jack, Chere-O-Kee. Will have sorrel babies bred to a sorrel jack. She has a neat head, good bite, straight legs, great body conformation, and a nice disposition. She is a good producer of foals with quality conformation. Dam of the National Champion Jennet and Champion of Breed at Shelbyville, TN 2001. Should have a foal at her side at sale time. She will sell open. Always comes to you out in the pasture to be loved.

50

Southern Mountain Horse Company's Bittersweet

Dark Brown/Black & White Spot Jennet, 28" (Mar 2004)

Consignor: Southern Mountain Horse Company, July 6, 2003, Reg # Pending

Southern Mtn Horse
Co.'s Tecumseh
31" Gray & White Spot

— [Unknown
Unknown

— [Unknown
Unknown

Indian Tree Farm's Anita
31.5" Dark Brown

— [ITF' Little Boy Blue
33" Frosted Spotted
White/ Slate
ITF's Barbara
34" Black

— [Bumpus Cunningham Moses
33" Slate Gray & White Spot
Cunningham's Light,
Not Registered
Unknown
Unknown

Very nice, well built jennet, good straight legs, great color, will stay small. Father is our 31" tall Spotted Jack Tecumseh, who produces 75% spotted color on his foals. Her mother is a beautiful 32.5" dark chocolate jennet. With this jennet we will provide to the buyer a guarantee of reproductive soundness.

51

Perfection's All Jetted Up

Russet Brown Jennet, Birth Height 20"

Consignor: Perfection Miniature Donkeys, Aug 21, 2003, Reg # Pending

Perfection's Jett
(aka Stoney Acres Jett)
31" Black

— [MGF Future Link
32" Black
Circle C Promises
Black

— [Dodge City Jack of Spades
31.5" Black
MGF Venus Giselle 27
33" Brown
Little Motown
35" Black
Circle C Promise Me
Black/Brown

MGF All Fired Up
33" Dark Sorrel

— [The Fireman
32" Dark Sorrel
MGF Venus Katie Rose
35" Dark Sorrel

— [DMF Junior
33" Grey-Dun
Grumpy
Brown/Slate
The Fireman
32" Dark Sorrel
MGF Venus Kathryn 39
32" Dark Brown

Rich Warm Hot Chocolate best describes this little sweet heart! The color of hot chocolate on a cold winter day, the personality of the whip cream on top...SWEET. A daughter of the great JETT and a great granddaughter of the legendary Venus Kathryn 39. This is a pedigree that traces back to imports several times. All Jetted Up is destined to succeed in the show ring, and the breeding pasture. Don't miss this chance to acquire the only non-black Jett daughter we will sell this year.

52

MGF Tiny Spark

Dark Red/Brown Jennet

Consignor: McRoberts Game Farm, Oct 7, 2003, Reg # 38418

MGF Little Pink Harry
30.5" Gray &
White Spot

— [CP's Harry
31" Gray-Dun
MGF Venus Nasturtium 91
33" Brown/slate
& White Spot

— [Rosebud II
Unknown
GP Peanut
32.5" Brown & White Spot
MGF Venus of Naxos 17
32" Brown

MGF Venus Geofire 514
32.5" Red/Brown

— [The Fireman
32.5" Dark Sorrel
MGF Venus Miss Geordie 68
33" Dark Brown (Blk/Brn)

— [DMF Junior
33" Rose Dun
Grumpy
Brown/Gray-dun
LCR Valentino 50
32" Dark Sorrel, MSF
LCR Philamena 70
32" Dark Brown

Under 30"....This little jennet is the smallest sorrel jennet I've ever raised!!!! Small, wide chest, stocky and alert.. Very nice movement and comes up to you in the field.

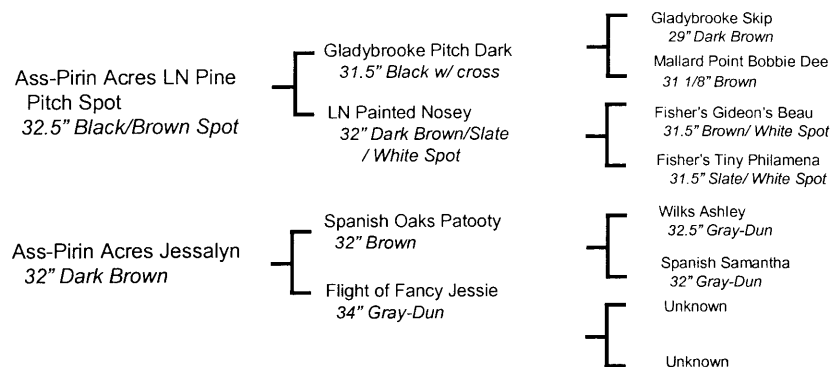
53**Ass-Pirin Acres *Miss Vickie*****Black Jennet, Birth Height 21.5", 33.5" (May 04)****Consignor: Ass-Pirin Acres, Jun 8, 2002, Reg # pending**

Miss Vickie is a two year old, black, drafty and sweet, sweet. This jennet has been fed well and is broadening out which tells us she pretty much is done growing in height. She comes from small stock, with a good pedigree.

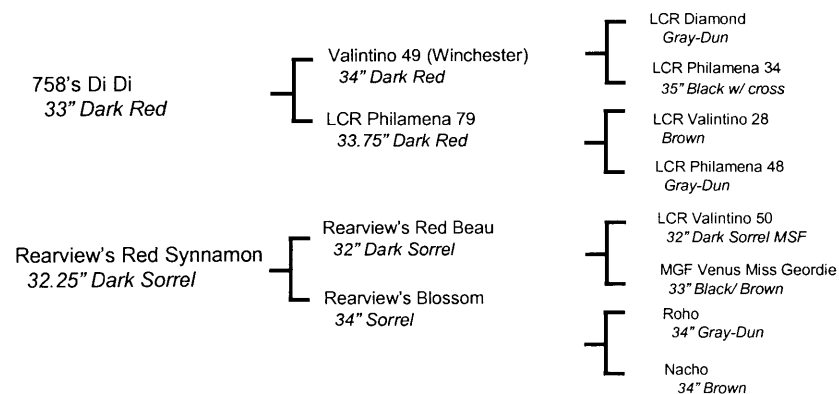
54**The Elms *Scarlet Dream*****Dark Sorrel Jennet, Birth Height 21.5"****Consignor: Elms Farm Miniature Donkeys, July 30, 2003, Reg # Pending**

Gorgeous Dark Red!!! Full sister to our herd sire, The Elms Eric the Red, full sister to Scarlett O'Eara in last year's sale, and also to The Elms Synnamon's Star (shown by Cody Bartlett). Every bit as beautiful as her sibs, great structure, fabulous color, willing personality. This is 'The' Sorrel Jennet everyone dreams of having in their field. You're not asleep.... This dream of a jennet can be yours today!!!!



MINIATURE DONKEY SALE™

Elms Farm Miniature Donkeys

The Elms Farm

Martha & Dowell Howard

5600 Bethany Road

Mason, OH 45040

513-398-3341

WWW.DONKEYS.NET

donkeys@donkeys.net

FIRST CLASS