



**Saturday July 30, 2005  
Historic Lebanon, Ohio - Fairgrounds**

.....  
***Select Miniature Donkeys from Breeders  
Across North America***  
.....

***Quality Conformation, Diverse Pedigrees, All Colors,  
100% Jennets - Yearlings, 2 year olds, Mature, Bred and With Foal***  
.....

**Visit [WWW.DONKEYS.NET](http://WWW.DONKEYS.NET) for  
Web Catalog with pictures**  
.....

***Sale Sponsors***  
**Elms Farm Miniature Donkeys**  
**The Elms Farm**  
**Martha & Dowell Howard**  
**Mason, Ohio**  
**[donkeys@donkeys.net](mailto:donkeys@donkeys.net)**  
**513-398-3341**

*Welcome To*  
**The Great American Miniature Donkey Sale**  
*Historic Lebanon, Ohio*  
**At the Warren County Fairgrounds**

May, 2005

Dear Donkey Enthusiast,

We are pleased to invite you to The Great American Miniature Donkey Sale, a select sale featuring quality registered miniature donkeys. The Sale will take place on Saturday, July 30, 2005 at 12:30 PM, at the Warren County Fairgrounds, next to the Lebanon Raceway, in Building C, in Lebanon, Ohio. We hope you plan to attend.

The Sale will consist of 62 miniature donkey jennet lots. These miniature donkeys have been selected from those offered for consideration. Top breeders are consigning their best, as those donkeys publicly represent their farm and breeding program. It would literally take you many days, and thousands of miles, to view an assortment of available, quality stock like you will see represented at the Sale.

The selected miniature donkeys represent diverse bloodlines, great conformation, and a variety of sizes, colors & ages to attract breeders, show people, and donkey & equine lovers everywhere. Full information on each jennet, including pictures (as consignors make them available), may be found on our web page, [www.donkeys.net](http://www.donkeys.net).

There is something for everyone here, whether you are an experienced breeder, or just getting started. The jennets include; yearlings, coming 2 year olds, mature jennets, bred jennets, and jennets with foals on the side. Donkey tack, gifts and curios will be available for purchase. A silent auction with interesting and unique donkey items will raise money for the National Miniature Donkey Association (NMDA) Donkey Research Fund. Whether you are looking for a single jennet, a jennet with foal, brood jennets for your breeding program, or a loving pet, you are assured of finding only quality miniature donkeys at this sale.

The Great American Miniature Donkey Sale is more than a donkey sale; it is an event, a 'happening'. Donkey enthusiasts everywhere look forward to events such as this and we expect a large turnout from across the Continent. It is an opportunity for folks, both those with years of experience, and those first exploring miniature donkeys, to get together, share experiences, learn from each other, have some fun, make new friends, renew old friendships, and, oh yes, see, bid on, and purchase some of the finest quality miniature donkeys in North America.

We hope you plan to attend this year's Great American Miniature Donkey Sale. We are confident you will enjoy it.

*Thank You for Your Support*  
*Martha & Dowell Howard*

*PS - If you can't attend, but want to bid on the donkeys, please contact us before July 20 to discuss phone bidding, earlier is better. Sale Day telephones 513-225-1771 and 513-919-5613.*

*The Great American Miniature Donkey Sale*

**SCHEDULE of EVENTS**

**FRIDAY JULY 29, 2005 SALE SET-UP DAY**

Friday is primarily a set-up and check-in day for the Sale. All donkeys must be on site by 4:00 to allow for consignor and vet check-in. There will be limited viewing during the late afternoon. Events are planned as follows:

Viewing Begins	2:30
Silent Auction Start	4:30
Consignor's Invitational Dinner	6:00
Measurement	7:00

**SATURDAY JULY 30, 2005 SALE DAY**

Saturday is the Sale Day. Viewing will begin at 8:00. Breakfast & lunch will be available for purchase. The proceeds of the Silent Auction of donated donkey related items will benefit NMDA Donkey Research programs. Please bring your donations to the Sale. The Donkey Sale starts at 12:30 and checkout begins shortly after the last lot is sold. Donkey tack, gifts, useful items and curios will be available.

Viewing Starts & Silent Auction Continues	8:00
Sale Vendors	9:00
Sale Starts	12:30
Payment, Vet Papers	Shortly after last lot is sold
Silent Auction ends	15 minutes after the Sale
All Donkeys Gone	before 8:00 PM

**SUNDAY JULY 31, 2005 ELMS FARM OPENHOUSE**

We would like to invite everyone to The Elms Farm Open House Sunday after the Sale from 8:30 until? We're close to Lebanon and are between I-75 and I-71 for easy access. Directions: Turn right leaving the fairgrounds, go straight thru town, bear right onto Rt 42. Go about 6 miles. After you pass the Kirkwood Inn, turn right on Bethany Rd., go 1.9 miles to The Elms Farm. Stop by and see our herd, have some refreshments, and talk donkey. We are looking forward to seeing you.

**SALE LOCATION & DIRECTIONS**

The Sale will be held at the Warren County Fairgrounds, Bldg C, adjacent to Lebanon Raceway located on Route 48, 0.7 miles north of the town center of Lebanon, OH. You enter through Gate 4. The Lebanon Raceway, a private company, will be in operation, so no parking on paved areas. Parking for the Sale will be indicated.

From I-75, take exit #29 (Monroe, Lebanon, Rt 63) east to Lebanon, 7 miles. Turn left on Broadway (Rt 48 North), go 0.7 miles to the Fairground.

From I-71, take exit #28 (Rt 48), turn North, go about 2 miles to Rt 123, exit west toward Lebanon, go 1 mile, turn right on Broadway, go 0.7 miles to the Fairground

**Auctioneering & Clerking**  
**Kevin Wendt, Auctioneer**  
**[www.thewendtgroupp.com](http://www.thewendtgroupp.com)**

# *The Great American Miniature Donkey Sale*

## TERMS AND CONDITIONS

**Terms:** Terms of the sale are cash or good check, with photo identification. All donkeys must be paid for immediately at sale end. No animals may be removed prior to close of the sale, and all donkeys must be removed from the premises by 8 PM, unless other arrangements have been made with the sponsors. (We can help you if you want to attend / phone bid, but won't have a trailer at the Sale. Call us.)

**Bidding:** All donkeys sell to the highest bidder. Any disputes or challenges will be settled by the auctioneer, and his decision will be final. The auctioneer may reject any or all bids. Bids are per lot. Jennets with foals on the side sell as one lot.

**Risk:** The owner assumes all risk for the donkey up to the point of sale. The buyer assumes all risk at the moment the auctioneer declares the animal is sold. The management is not responsible for loss or damages to personal property.

**Announcements:** All announcements on sale day from the auction block will take precedence over the material printed in this catalog. Every effort has been made to ensure the accuracy of the catalog. However, we assume no liability for errors or omissions.

**Contract:** The management, auctioneers, and employees act as agents for the seller, but assume no liability for either the buyer or the seller. Any representations made by the sales management are made on behalf of the seller.

**The above terms and conditions shall constitute a contract between the buyer and the seller of each animal sold. All guarantees are between buyer and seller.**

**Health:** The EIA/Coggins test will be less than 6 months old. Current health papers for transportation with state stamp should be good for 7 days past sale date. Proof of pregnancy from a veterinarian is required for bred jennets, otherwise sold as exposed. **Buyers are responsible to obtain the paperwork they need from the veterinarian after payment immediately following the Sale.**

**Transport:** We may be able to help you get your donkey(s) home. Please let us know if you may need this assistance.

**Export** – The buyer will assume all costs incurred for additional veterinary work, quarantine, shipping, and any necessary expenses. For further clarification, please contact us – we export frequently.

**General:** Please note that donkey heights in the catalog have been provided by the seller. These may be adult or immature heights and are included only as helpful data. We encourage you to measure donkeys you are interested in purchasing, if the data provided seems inaccurate via visual inspection. All donkeys will be measured in public view at a designated area after arrival at the fairgrounds.

### Absentee/ Phone Bids

Please contact Dowell or Martha Howard at 513-398-3341 by July 15 for details.

**Please Bring This Catalog – Supplies Are Limited**

# *The Great American Miniature Donkey Sale*

## CAMPING & LODGING

**Camping:** Camping is available Friday night at the Fairgrounds for \$10. Water & electric hook-ups, dump station, restrooms & **HOT** showers. 250 ft from the Sale.

**Historical Lodging:** The Golden Lamb, 27 S. Broadway, Lebanon, OH 45036, 513-932-5065, goldenlamb.com, Ohio's oldest Inn, 200 years of US history. 8 Presidents, Mark Twain & Charles Dickens stayed here, 1 mile to the Sale

**Bed & Breakfast:** The Hatfield Inn, 2563 Hatfield Rd, Lebanon, OH 45036, 513-932-3193 or 888-247-9793, www.bbonline.com/oh/hatfield/, 1810 renovated home on 55 Ac farm, large rooms. 5 miles to Sale. Nice, breakfast

**Motels** – Just a selection, many more listed on the web site – [www.donkeys.net](http://www.donkeys.net)

### Lebanon (I-71 Exit # 28 or I-75 Exit # 29)

**Golden Lamb Inn**, 27 S. Broadway, Lebanon, OH 45036, 513-932-5065, www.Goldenlamb.com. quoted 2005 prices \$87.00 - \$113.00 double

**Shaker Inn**, 600 Cincinnati Ave (on Rt 42), Lebanon, OH 45036, 513-932-7575, 800-752-6151, www.Shakerinnmotel.com, contact Andrea S. Broadway, quoted 2005 prices \$54.00 - \$72.00 double

### I-71 Exit # 25

**Kirkwood Inn**, 4030 S US Rt. 42, Mason, OH 45040, 513-398-7277, 800-732-4741, www.kirkwoodinn.com, contact Sandy or Dave, quoted 2005 prices \$79.95 double (near Houston restaurant – reasonable priced American food – good)

### I-75 Exit # 29

**Super 8 Motel**, 150 New Garver Rd, Monroe, OH 45050, 513-539-2660, 800-800-8000, www.super8.com.

**Days Inn**, 120 Senate Drive, Monroe, OH 45050 513-539-2660, 800-329-7466, www.daysinn.com

**Hampton Inn**, 40 New Garver Rd., Monroe, OH 45040, 513-539-4400, 800-hampton, www.hamptoninn.com

## *Elms Farm Miniature Donkeys*

**We strive to produce quality miniature donkeys with excellent conformation, great dispositions and personalities**

- \* **Correct, drafty donkeys, with emphasis on sorrels, blacks, & darks.** □
- \* **Large sorrel herd, one of the most genetically diverse anywhere.**
- \* **5 Herd Sires - 3 Sorrels, 2 Blacks**
- \* **Every foal carries sorrel or black genes or both.**
- \* **Breed stock selected from herds across North America**
- \* **Each mating planned to strengthen desirable characteristics.**
- \* **Foundation Herd Planning – Export Expertise – Carts & Harness**
- \* **'Shipping Around the Corner or Around the World'**

## 2005 Consignor List

### Arcadian Exotics

Paul & Gertrude Suorsa  
133 Branchton Rd  
Slippery Rock, PA 16057  
724-794-3288  
gsuorsasr@aol.com  
Lot 29

### Bunker Hill Miniature Donkeys

Les Bunker & Linda McHugh  
12498 Guelph Line  
RR#1 Campbellville, ON  
CANADA LOP 1B0  
519-856-4532  
bunkerhillminidonks@hotmail.com  
Lots 7, 46

### Elms Farm Miniature Donkeys

Dowell and Martha Howard  
5600 Bethany Road  
Mason, OH 45040  
513-398-3341  
donkeys@donkeys.net  
www.donkeys.net  
Lots 1, 11, 19, 27, 41, 52, 62

### Feather Ridge Farm

Dennis Banning  
521 Mill Street  
Williamston, MI 48895  
517-655-3873  
Lots 5, 20, 33, 51

### Heiken's Ark

Dick & Kathy Heiken  
PO Box 35456  
Des Moines, IA 50315  
515-962-0667  
heikensark@aol.com  
www.heikensark.com  
Lots 4, 14, 25, 49, 60

### Half Ass Acres

Joe and Dayle Haworth  
2359 Feed Mill Rd.  
Chapel Hill, TN 37034  
931-364-3715  
minidonks@united.net  
www.minidonks.com  
Lots 10, 44

### Horse Creek Farm

Wendy Herrick Nye  
9516 Mulberry Rd  
Chesterland, OH 44026  
440-729-1422  
pwnyehcf@adelphia.net  
Lots 21, 54

### Lamb's Exotic Ranch

Paul & Edna Lamb  
1056 N 800 E Road  
Bement, IL 61813  
217-678-7241  
Lots 8, 45, 57

### Little Bit of Heaven

Jack and Sue Pentland  
6480 W 900 N  
Royal Center, IN 46978  
574-643-9359  
jack@cqc.com  
www.littlebitofheavenminidonks.com  
Lots 18, 38

### Long Run Farm

Betty and K.C. Stegemoller  
3500 Utica Rd.  
Lebanon, OH 45036  
513-932-1601  
longrunminidonks@aol.com  
Lots 17, 24, 39, 47

### Lyons Bros Farm

Tom & Sherry Lyons  
11 N. County Rd 1000E  
Arcola, IL 61910  
217-268-4526  
Lots 31, 56

## 2005 Consignor List

### Maxwell Ridge Farms

Peter & Mari Maxwell  
245 New Grafton Rd.  
Caledonia, NS  
CANADA BOT 1B0  
902-682-3161  
Maxwell.donkeys@ns.sympatica.ca  
www.maxwellridgefarm.com  
Lots 9, 36, 43

### McRoberts Game Ranch

Jerry & Barb McRoberts  
P.O. Box 55  
Gurley, NE 69141  
308-884-2371  
jbmcrob@daltontel.net  
www.mcrobertsgamefarm.com  
Lots 3, 12, 28, 34, 40, 61

### Merry-Go-Round Minis

Marlene Clark  
14500 Van Syckle Rd.  
Gregory, MI 48137  
734-498-3590  
grclark@direcway.com  
Lots 6, 23, 37, 59

### Moore Mini Farms

Gerald Moore  
38895 State Rte 143  
Pomeroy, OH 45769  
740-992-2822  
dagger@dragonbbs.com  
Lot 32

### Lazy N Ranch

Jon, Mary & Jay Nissen  
1080 Hwy 17  
Corwith, IA 50430  
515-824-3603  
nissens@lnminidonk.com  
www.lnminidonk.com  
Lot 15, 42, 55

### Oleo Acres

Jayne Fisher  
8710 Hume Lever Rd SE  
London, OH 43140  
740-852-0349  
fishy8710@peoplepc.com  
www.oleo-acres.com  
Lot 35

### Parkside Ranch

Linda & Jeff Armstrong  
3926 Lorilin Dr  
Batavia, OH 45103  
513-404-2195  
parksideranch@fuse.net  
www.parkside-ranch.com  
Lot 30

### Perfection Miniature Donkeys

Val & Deone Townsend  
RR1 Site 7 Comp 14  
Sylvan Lake, AB T4S 1X6  
CANADA  
403-887-2285  
lsangus@telusplanet.net  
www.perfectionlamas\_  
miniaturedonkeys.com  
Lots 2, 13, 26, 48, 58

### Sunset Acres

Bob & Cindy Lowenstein  
1103 E. Sunset  
Grand Island, NE 68801  
308-382-7474  
donkeys@charter.net  
www.minidonkeys.net  
Lots 16, 50

### Willmann West Prairie Farm

Gene & Betty Willman  
5455 West Prairie Drive  
Belleville, IL 62220  
618-235-0221  
gene.willmann@att.net  
Lots 22, 53

1

### The Elms *Bonnie Glow*

Red Jennet, May 27, 2005, Reg. Pending

Consignor: Elms Farm Miniature Donkeys, 22 1/8" at Birth

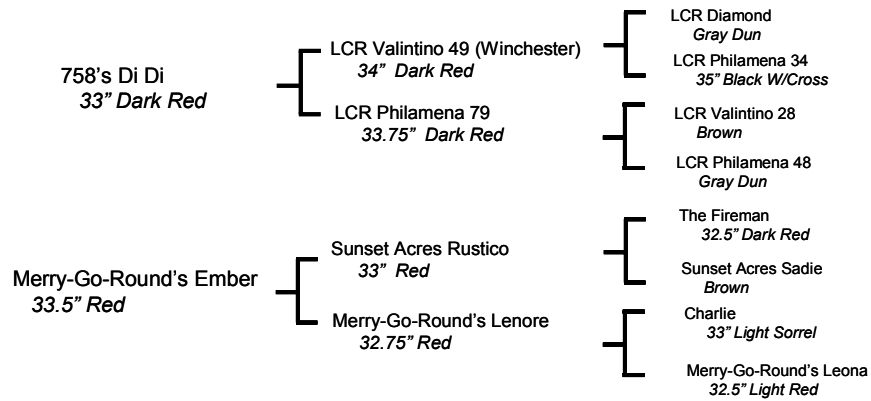

We're kickin' off this sale with a great, beautiful, straight, sorrel jennet, Bonnie Glow. 'Bonnie' because she is pretty and 'Glow' because of her rich red color. She has a wide chest, and the stocky, straight build Di Di produces. Di Di has crossed well with Ember in the past and Bonnie Glow is no exception. Don't overlook this jennet!

2

### Perfection's *Misty Mystical*

Black w/Cross Jennet, Sept. 14, 2002, Reg. Pending, Bred for 2006

Consignor: Perfection Miniature Donkeys, 21.75" at Birth

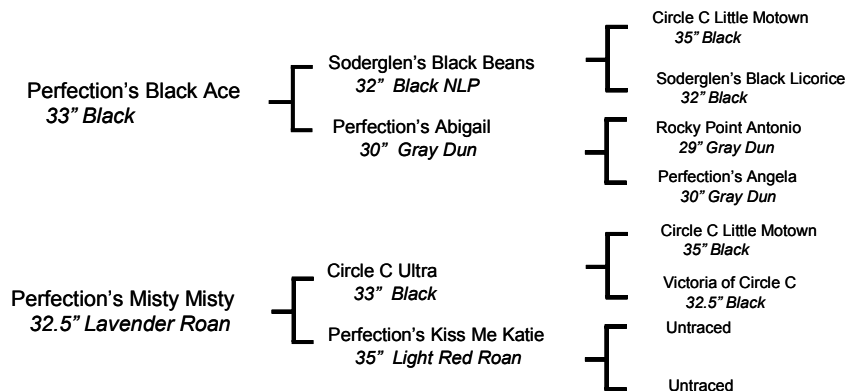

Misty Misty, can you do no wrong? A great daughter from one of the farm favorites. Misty Mystical represents 4 generations of Perfection breeding. Now what to do...Let's breed her to JETT (30.5" black) and get ready to hold on! This baby is going to be a super star from the moment it is born.

3

### MGF *Pink Champagne 316*

Red\* White Jennet (Frosted Spotted White), July 25, 2003, #41777

Consignor: McRoberts Game Farm, 32" in May 2005

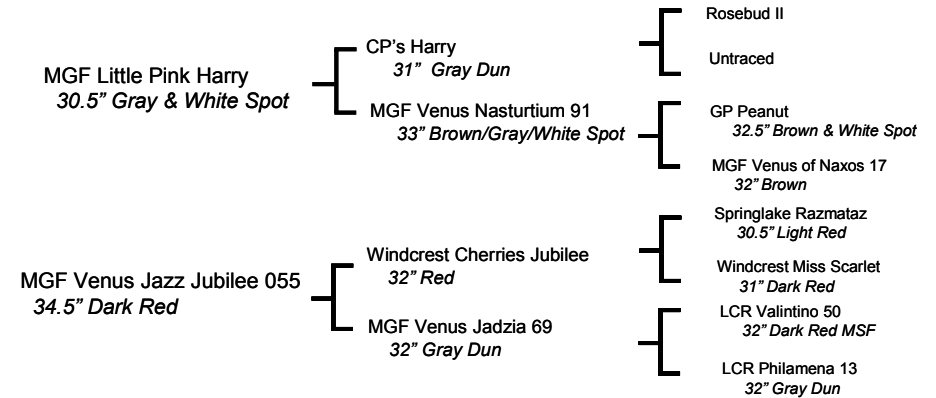

This frosted sorrel jennet is stocky and is an interesting color. Can't wait to see her in her summer coat. Her sire - Little Pink Harry is super stocky with lots of hair. Her dam is a very nice dark red Cherries Jubilee daughter. She is a friendly, mature looking 2 year old.

4

### Heiken's Ark *Bubbles I*

Dark Brown Jennet, May 4, 2004, Reg Pending

Consignor: Heiken's Ark, 20.75" at Birth

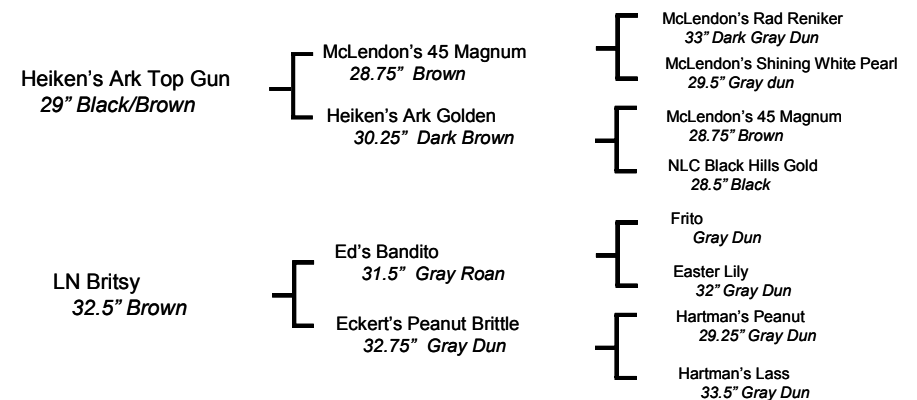

This little jennet lives up to her name. She is super friendly, and just bubbles with personality. Her dark brown color and 20.75" birth height are just bonuses. She has a great pedigree which includes Top Gun and Magnum. Don't let her get away.

5

**Feather Ridge's Schwanda**

Black w/Cross Jennet, May 12, 2003, Reg. Pending

Consignor: Feather Ridge Farm

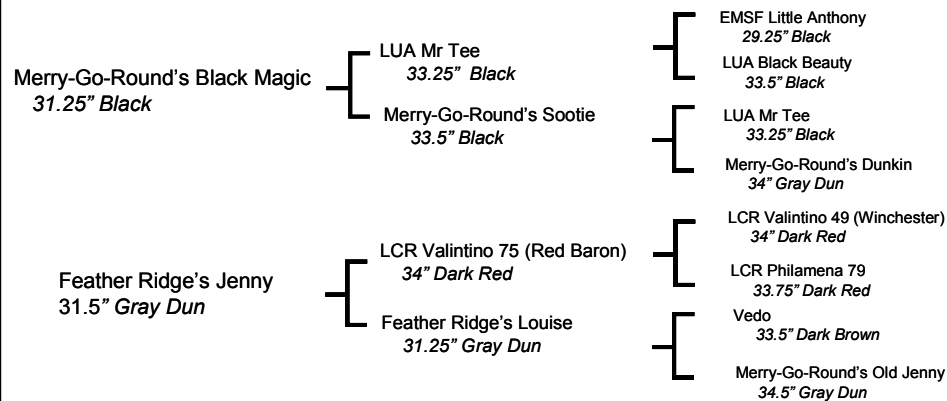

Schwanda's a nice, well built jennet with sorrel and black genes all wrapped up in one package. Red Baron on her Dam's side, and Black from her Sire. Think you could get some interesting babies out of this gal bred to sorrel or black.

6

**Lucky Star's Inky Dinky Doodle**Merry-Go Round's *Dinky Dazzle*, Jennet foal

Brown/Gray Dun 32.5" Jennet, June 14, 1999, #25381, Bred for 2006

Black/Brown Jennet Foal, April 7, 2005, Reg. Pending, 21" at Birth

Consignor: Merry-Go-Round Minis

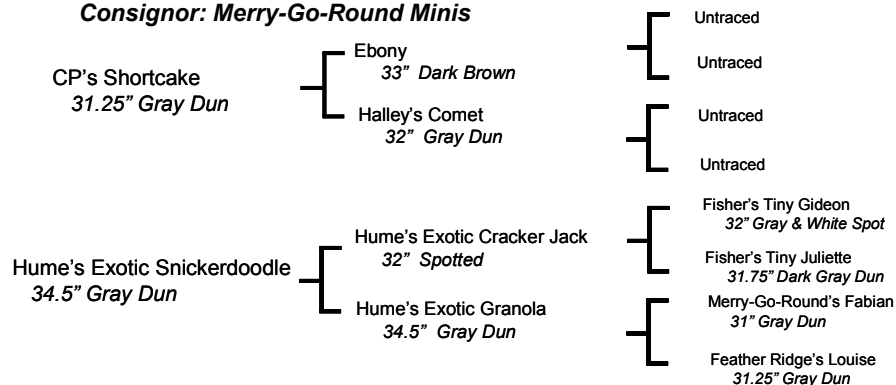

Doodle is a nice jennet, and produces very dark, gorgeous foals. She is bred back for 2006 to Merry-Go-Round's Carbon Black (a small black jack sired by DD Aces High, and out of Merry-Go-Round's Sootie). Dazzle is a lovely foal, compact with a real pretty head. Her Sire is Merry-Go-Round's Black Magic (31.25" Black). Don't miss this 3 in 1 package, loaded with color and variety.

7

**Bunker Hill Lady in Red**

Dark Red Jennet, May 31, 2003, CDJE-4046

Consignor: Bunker Hill Miniature Donkeys

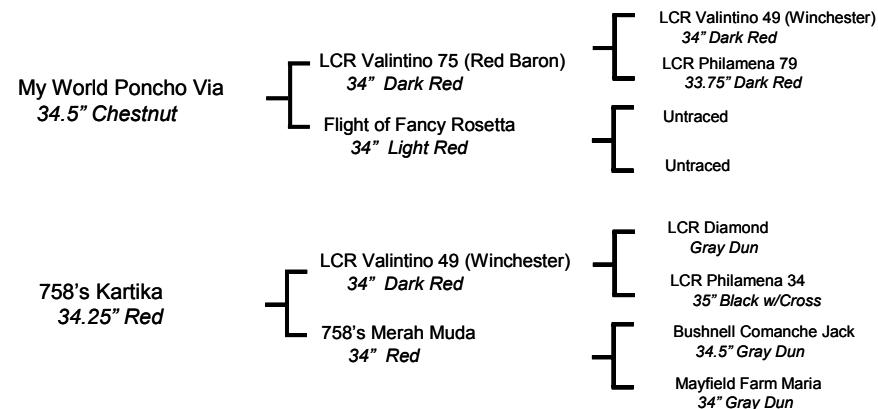

Lady's colour, conformation, plus being sired by Halter and Performance Champion, My World Poncho Via, and her Dam sired by Winchester, says it all. What more could you want!

8

**LER Knite-N-Gail**

Black/Brown Jennet, Mar. 25, 2004, Reg Pending

Consignor: Lamb's Exotic Ranch, 21" at Birth, 30.25" in Mar. 2005

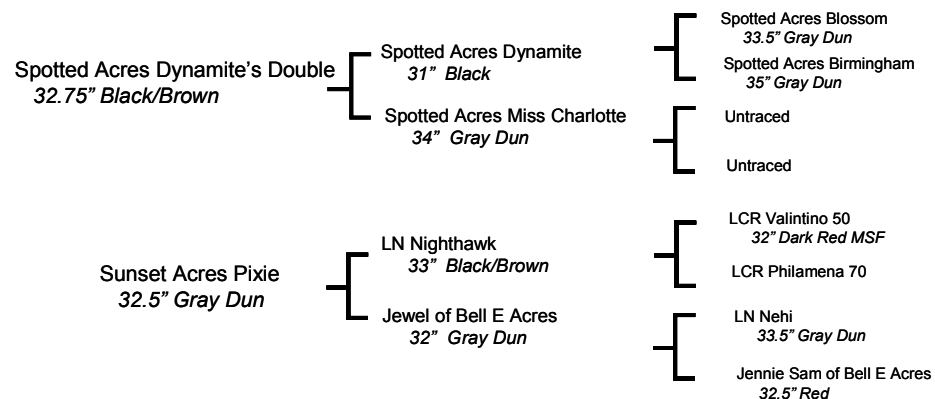

Here's a real smooth black/brown jennet that will make a real good producer in your herd. She has the bloodlines that will produce the right kind of babies. Good body conformation, correct bite, good straight legs and a wonderful disposition. Her sire is a good black jack, dam is slate and has been producing some real good foals. Don't over look her

9

## Valean's *Carmelita*

Black/Brown Jennet, Aug. 15, 1994, #CDJE-1792, Bred for Sept. 2005  
 Consignor: Maxwell Ridge Farm, 31 3/8"

Valean's Darby Dan  
 32" Black

— Untraced  
 — Untraced

Chita 5730  
 31" Gray Dun

— Untraced  
 — Untraced

Carmelita means black/brown in Spanish. She is a supreme brood jennet. She foals easily, and has been an exceptional mother to small, black, very correct jennet foals. She has excellent conformation, color, and size. She is confirmed in foal to Country Music's Aaron Neville (black/brown 31") for the end of September, 2005. Here's a great opportunity to add 'Carmelita' genetics to your breeding program.

10

## HAA *She Bangs*

Dark Red/Brown Jennet, Apr. 30, 2004, #38547  
 Consignor: Half Ass Acres Miniature Donkeys

PGF Peppercorn Jack  
 29" Brown

— My World Buster  
 30.25" Dark Red  
 — PGF Rhubarb  
 31.5" Gray Dun

— My World Mork  
 30.5" Dark Gray Dun, NLP  
 — My World Mindy  
 31" Dark Brown

— Wendell  
 30" Gray Dun  
 — Tulip  
 31" Gray Dun

Half Ass Acres Oprah Winfrey  
 33.75" Black/Brown NLP

— Fisher's Great Gildersleeve  
 32.25" Brown/Gray/White Spot  
 — Half Ass Acres Whoopi  
 33.5" Black w/Cross

— Fisher's Tiny Gideon  
 32" Gray & White Spot  
 — Fisher's Bit O' Honey  
 32" Gray Dun

— Rastus  
 29" Black  
 — Ferncroft's Oda May  
 35" Gray Dun

We just have one thing to say about this jennet.....WOW!!!!!!!!!!!!!! She is a full sister to Mercy Me that sold for \$5800 in the 2003 Great American Miniature Donkey Sale. We never dared to dream that this combination would produce a sorrel, but here she is, and just like her name implies.....she bangs!!!

11

## The Elms *Vivi Va Voom*

Black, No Cross, NLP Jennet, Aug. 9, 2004, #40390  
 Consignor: Elms Farm Miniature Donkeys, 21" at Birth

EA Dr. Chaboom  
 32" Black NLP

— EA Rambler  
 33" Dark Brown  
 — EA Tabatha  
 32" Dark Gray Dun

— LCR Valentino 58  
 31.5" Dark Brown  
 — EA Tabatha  
 32" Dark Gray Dun

— WXICOF Walter  
 34" Gray & White Spot  
 — EA Samantha  
 32.75" Gray Dun

J & L Mini Stables Dark Angel  
 32" Black w/Cross NLP

— SS Red Lightening  
 32" Red  
 — J & L Mini Stables Sophia  
 35" Black

— SS Sampson  
 32.85" Dark Brown  
 — SS Sara  
 31.5" Dark Brown

— Circle C Little Motown  
 35" Black w/Cross  
 — Karisma of Circle C  
 35.75" Dark Brown

Va Voom! This little black jennet hit the ground and blew us away! Full of life, hence the name Vivi. Here is an elegant, small, all black jennet to delight. She has a velvety look to her black coat. Very nice structure, and classy, feminine style. Her foal coat bleached to that reddish cast the blackest donkeys show as foals. We will find it hard to part with her.

12

## MGF *Red Hot Mama 416*

Dark Red Jennet, June 20, 2004, #41776  
 Consignor: McRoberts Game Farm, 29" in May, 2005

MGF RJ  
 32" Dark Red

— Windcrest Cherries Jubilee  
 32" Red  
 — MGF Venus of Naxos 17  
 32" Brown

— Springlake Razmataz  
 30.5" Light Red  
 — Windcrest Miss Scarlet  
 31" Dark Red

MGF Venus Sneaky Pink 872  
 Light Sorrel

— Carousel LL Inspector Clouseau  
 27.75" Light Red Roan  
 — MGF Venus Geofire 514  
 32.5" Red/Brown

— LCR Valentino 50  
 32" Dark Red MSF  
 — LCR Philamena 70  
 32" Dark Brown

— Carousel LL Theodore  
 28.5" Gray Dun  
 — Carousel LL Rosetta  
 31.75" Light Red/Gray Roan

— The Fireman  
 32.5" Dark Red  
 — MGF Venus Miss Geordie 68  
 33" Black/Brown

She's short - stocky - typy!!! This little dark sorrel female is one of the smallest we've raised....with Inspector Clouseau (under 28") on the maternal side. Her Sire...dark red RJ, is our best Cherries Jubilee son and is our current main sorrel breeder.

13

## Perfection's *Just Divine*

Gruella Jennet, Nov.1, 2004, Reg. Pending

Consignor: *Perfection Miniature Donkeys, 20.5" at Birth*

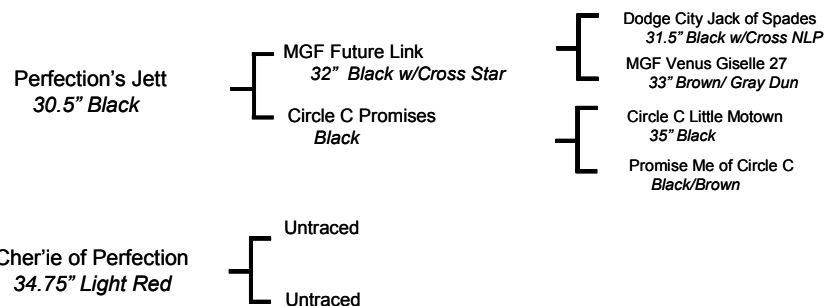

We like the fine things in life and beautiful colored donkeys is one of those things we covet. A 1/2 sister was exported to Gay James in the UK. Cher'ie we affectionately call our "Quarter Horse Jen" is a great show jennet as well, having won her class twice at the World Show and being Champion Jennet at the Miniature Donkey Extravaganza as well as winning the Champion Maturity Jennet.

14

## Heiken's Ark *Lolita*

Dark Gray & White Spot 33" Jennet, June 28, 2001, Bred for 2005  
Registration #33213

Consignor: *Heiken's Ark*

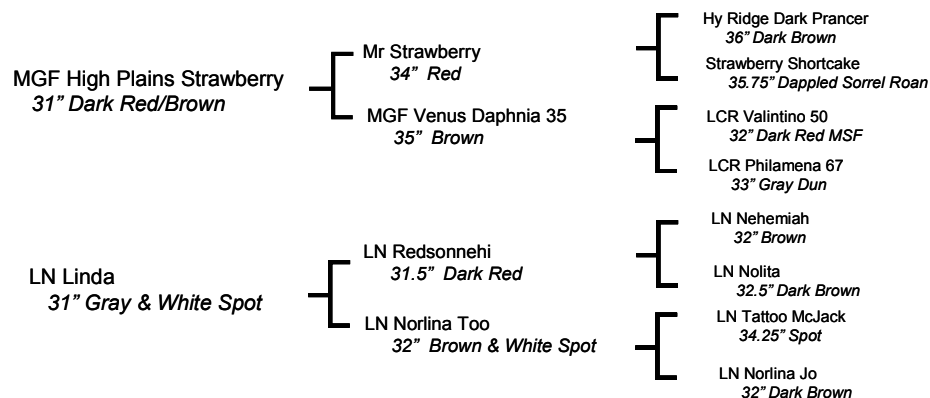

Lolita is a classy spotted jennet. She has a double dose of red in her pedigree with LN Redsonnehi and MGF High Plains Strawberry. She is bred to McLendon's 45 Magnum and should have a foal by her side at sale time. This foal will be only the third Magnum offspring offered for sale in 9 years.

15

## LN *Jessa Little Mop*

Dark Brown NLP Jennet, July 29, 2004, Reg Pending

Consignor: *Nissen's Lazy N Ranch, 21" at Birth, 30" at 9 Months*

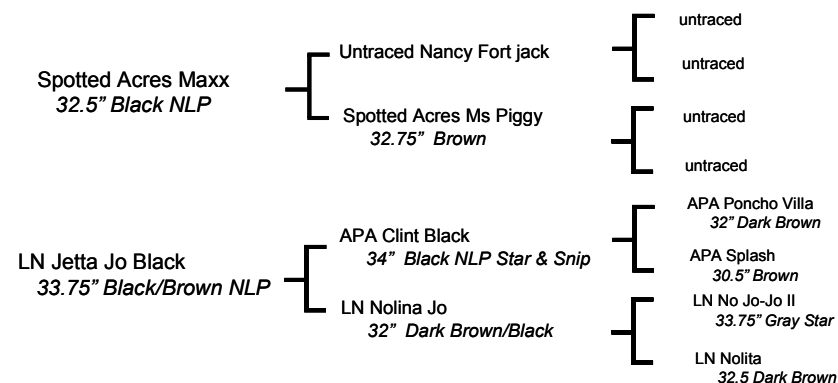

Mop's unique trait of the longer silky hair comes from both sides of her pedigree, but she is more than just a cute, fuzzy donkey. Dam, Jetta (dam of all dark girls, except one red) is out of Nolita Jo, one of our awesome ladies whose blood is also carried on by another daughter, Nicolina, granddaughter Nolauna & great grandson Red Glo. Maxx daughters are proving to be great producers, one the dam of a \$9000 Great American Sale topper last year. It will be a year before we'll possibly have another Maxx daughter to offer. Take a look now.

16

## Sunset Acres *Mystic Myryha*

Black W/Cross Jennet, Feb 14, 2005, #42036

Consignor: *Sunset Acres, 20.75" at Birth*

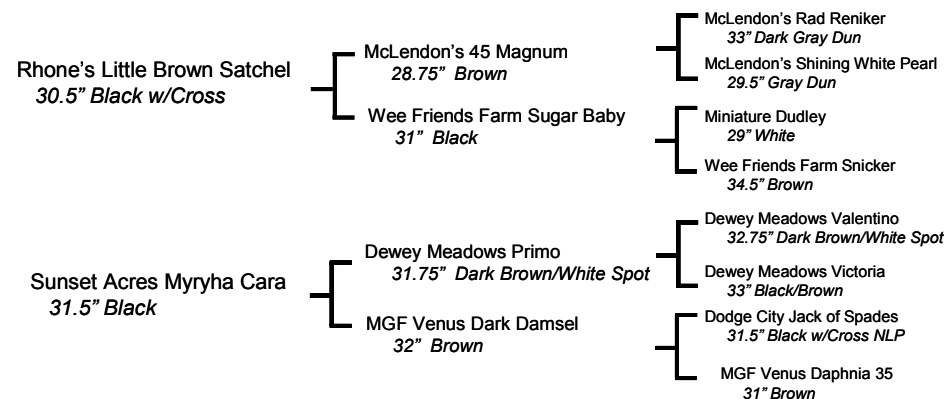

Mystic Myryha is our first female by Satchel. She has a wonderful and colorful pedigree with small genetics. Only 20.75" at birth, she will be a KEEPER for you!!



17

**J & E Carmen**

Gray Dun 34.5" Jennet, Apr. 29, 1999, #25297, Bred for 2006  
 Consignor: Long Run Farm

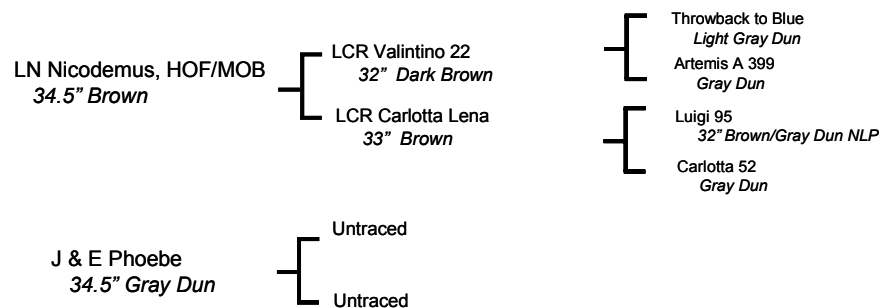

Carmen is the daughter of the multiple National Champion Nicodemus, and full sister to the 97 National Champion Jennet. She has produced 2 excellent foals and will be bred back to our dark brown son of Cash Dividend for a spring 2006 foal. Can you improve the quality of your herd? Yes, you can with Carmen!

18

**Heavenly Lu Lu**

Gray Dun Jennet, Mar. 12, 2003, #36833  
 Consignor: Little Bit of Heaven, 31.75" in Mar. 2005

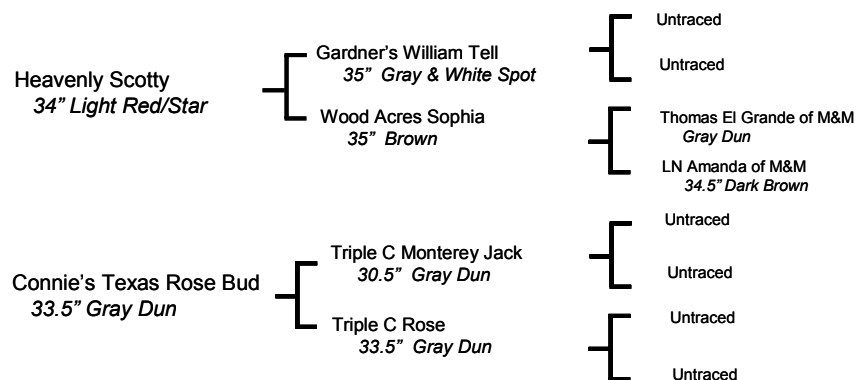

Lu Lu is a 2 year old classic gray dun, and she is nicely put together. She has good straight legs, and nice round rump, a good bone jennet. She has been shown at several shows and never placed below 2nd place. She is open and ready to breed to your jack.

19

**The Elms Firelight**

Dark Red Jennet, May 2, 2004, #40391  
 Consignor: Elms Farm Miniature Donkeys, 21.5" at Birth

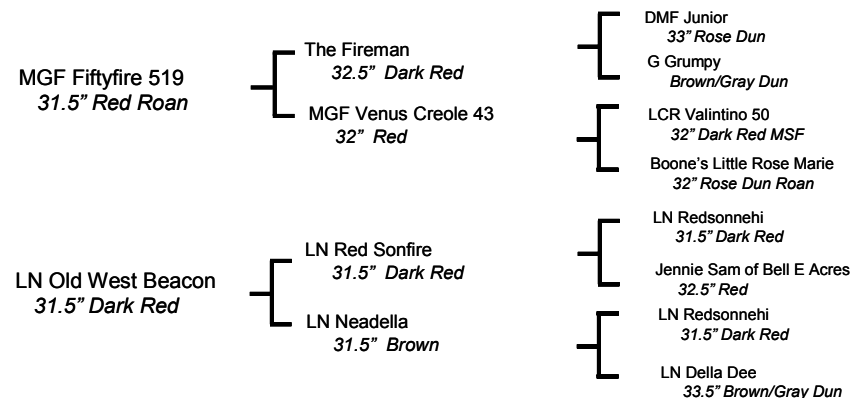

Firelight has style, lots of it! Flaming red color, lots of it! She has that Fiftyfire presence, small size, and the pretty head that draws your attention in the field. Beautiful by herself, Firelight is also half sister to ACOSA Champion, Sky's the Limit, and her Dam, Beacon, was the Nebraska State Fair Champion Jennet.

20

**Feather Ridge's Glimmer**

Dark Brown Jennet, Aug. 4, 2004, Reg Pending  
 Consignor: Feather Ridge Farm

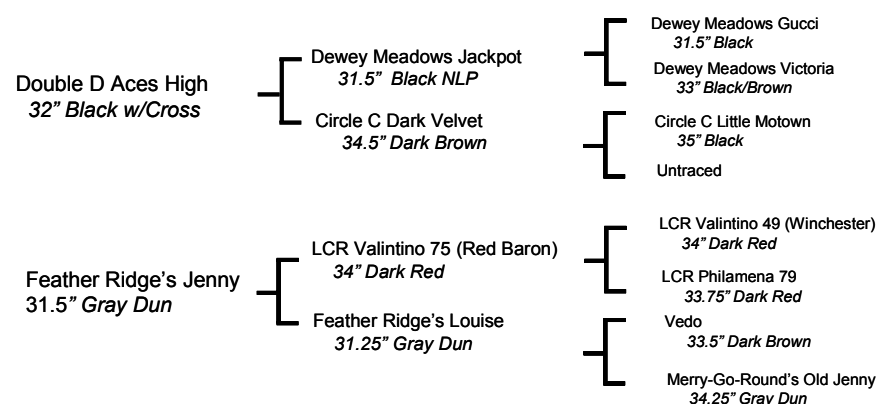

What a beautiful dark chocolate jennet! Her grandfather on the Dam's side is Red Baron, and the Grandsire on the Sire's side is Jackpot. Mom is a gray dun and Dad is a black. She has a lot of good genes in her, not to mention she's a beautiful, well built, little jennet. Very loving and a special little jennet.

21

**H.C.F Q-T-Pa-2-T**

Gray Dun 30" Jennet, Mar. 7, 2002, Reg Pending

Consignor: Horse Creek Farm

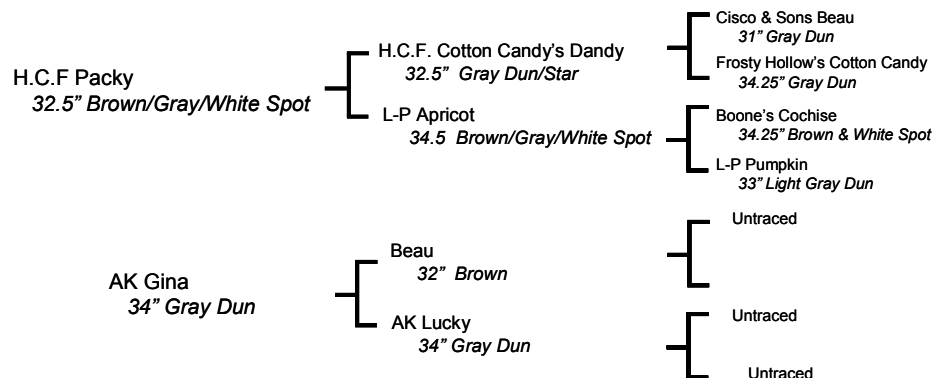

A real sweetheart (and my dog's best buddy!) "Tootie" is proof that good things come in small packages. In the traditional gray dun color, she's short and square with good bone. Point of interest, Tootie's sire H.C.F. Packy is the full brother of our other offering H.C.F. Holiday Joy. A compact little jennet ready to breed when you get her home, she truly is a cutie patootie.

22

**West Prairie Jenna**

Dark Brown Jennet, Apr. 1, 2004, Reg Pending

Consignor: West Prairie Farm, 23" at Birth, 31.5" in Mar. 2005

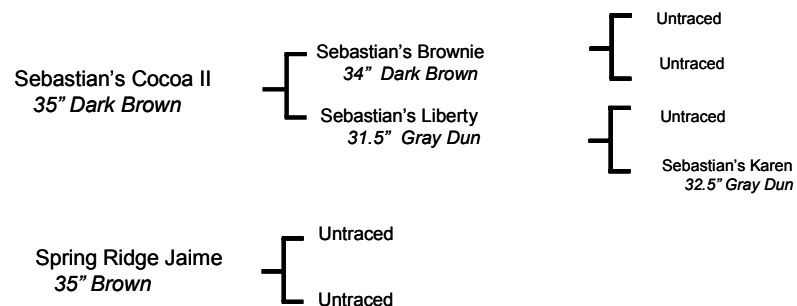

Jenna has dark brown genes on both sides mother & Sire. Great feet & legs, straight across back, great body and chest. She has three sisters, all are dark brown, and have dark brown offspring on the ground. Jennys run in the family. The offspring run smaller than parents. Jenna is a sweet little girl. She will make a nice addition to most herds. Gentle, good conformation.

23

**Merry-Go-Round's Nighten Gale**

Black w/Cross Jennet, June 28, 2004, #40682

Consignor: Merry-Go-Round Minis, 29.75" in Mar. 2005

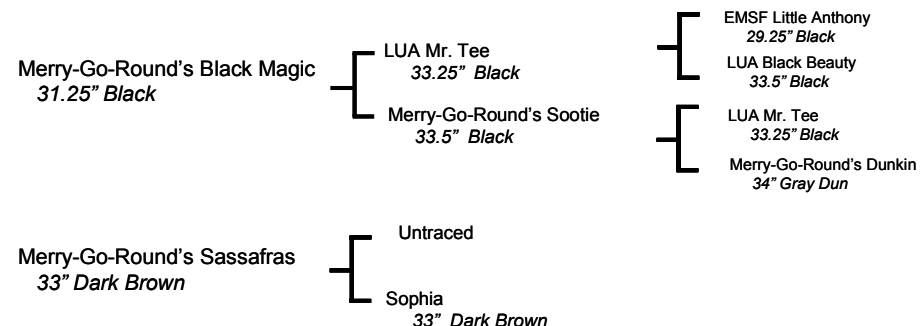

Nighten Gale is a black jennet. She is the full sister to Bewitched, in this sale last year. She is correct with striking light points, and she has a really nice head. She is going to be smaller than her sister.

24

**Long Run A Star is Born**

Dark Brown Jennet, June 1, 2004, Reg Pending

Consignor: Long Run Farm, 31" in Mar. 2005

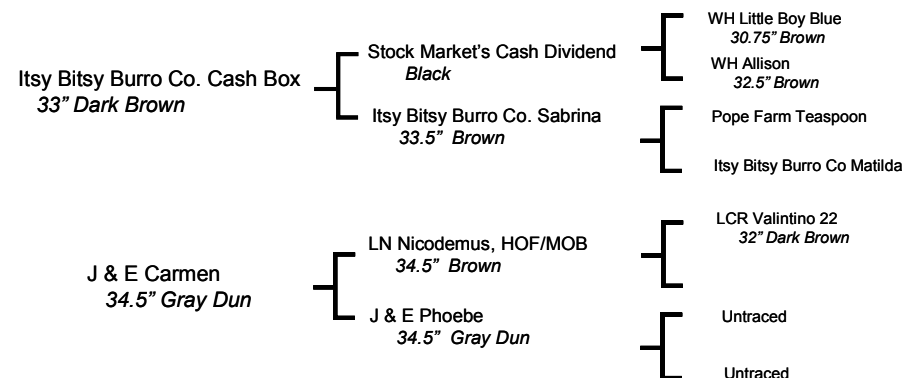

Star is a beautiful show quality yearling. Her paternal grandfather is 2 time National Champion Cash Dividend. Her maternal grandsire is 2 time National Champion Nicodemus. Her mother is full sister to the 97 National Champion jennet. Her pedigree also includes the good Texas jack, Teaspoon. Show her and then breed her. She can do it all.

25

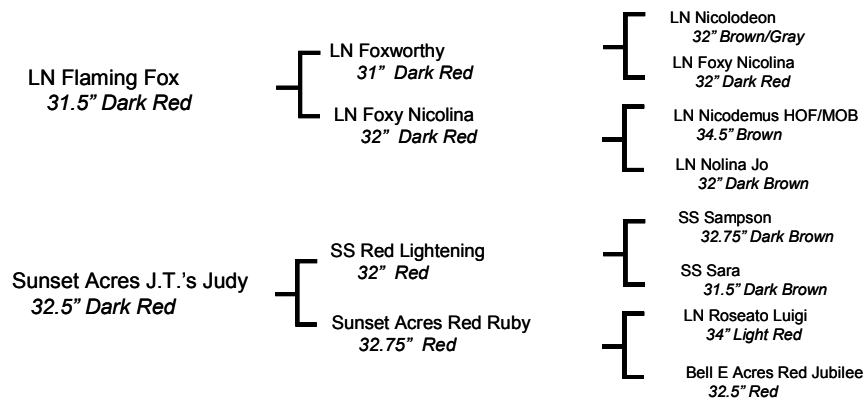
**Heiken's Ark *Jodi F*****Dark Red Jennet, Aug. 8, 2004, Reg Pending****Consignor: Heiken's Ark, 20.5" at Birth**

Jodi caught our eye from the day she was born. She always had her head up like she was so proud of herself. She has the red color all the way through her pedigree. With her birth height of 20.5", she should be a size that will fit in anyone's program.

26

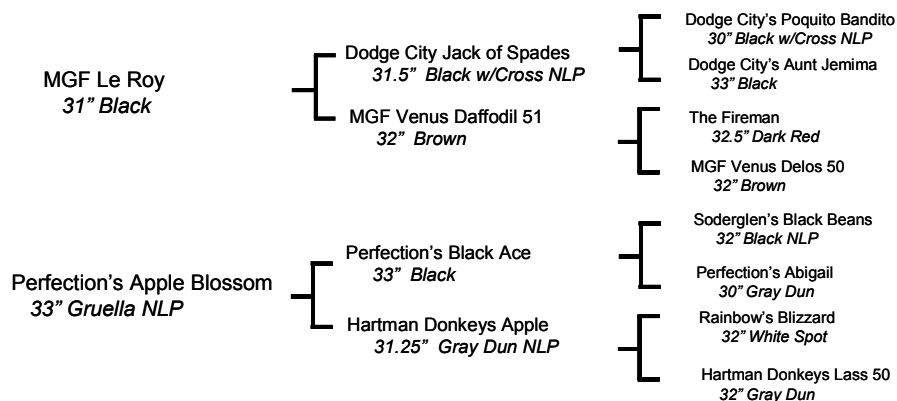
**Perfection's *Itsy Bitsy Blossom*****Gruella Jennet, May 12, 2003, Reg Pending****Consignor: Perfection Miniature Donkeys, 19.5" at Birth**

The Choirs and Angels from DC to France were singing when this little Blossom sprung. Itsy is a gorgeous gruella color, built as perfect as you could wish, and a sweetheart to boot. We will be showing Itsy at the NMDA National Champion Show in Calgary this summer, she is destined for greatness! From Blossom to Bounty, Itsy is sure to leave her mark.

27

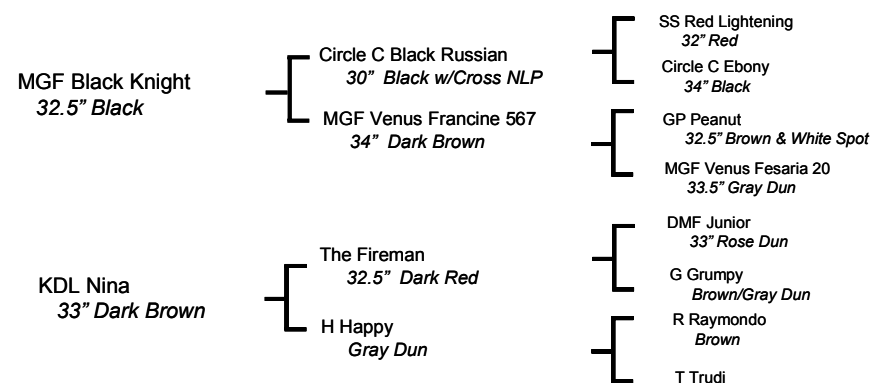
**The Elms *Precious Jewel*****Very Dark Brown Jennet, Sept. 6, 2004, #40389****Consignor: Elms Farm Miniature Donkeys, 22" at Birth**

She's gorgeous, she's solid, and she just melts your heart away. Black Knight is siring wonderful foals, stocky, great conformation, deep color, and mellow personalities. Precious Jewel is the richest dark chocolate color. Her maternal grandsire, The Fireman, is famous for great build. This Jewel is Precious!

28

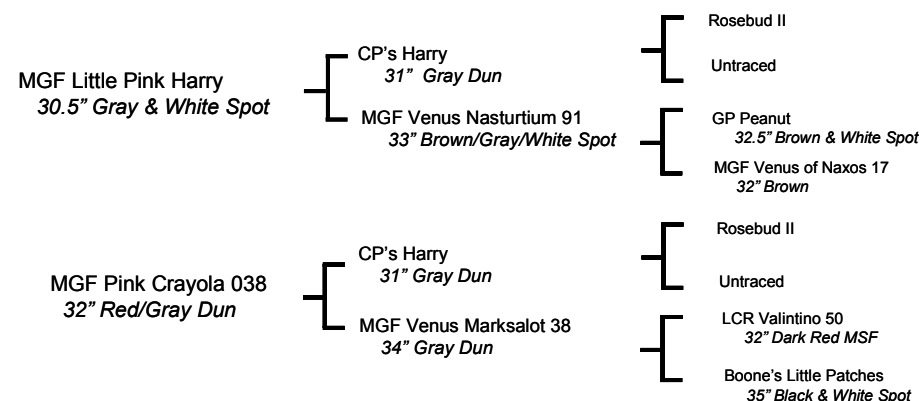
**MGF *Think Pink 322*****Light Red Jennet, June 29, 2003, #41772****Consignor: McRoberts Game Farm, 30" in May, 2005**

Very stocky light sorrel - line bred for color and wool (hair). Should mature at 31".

29

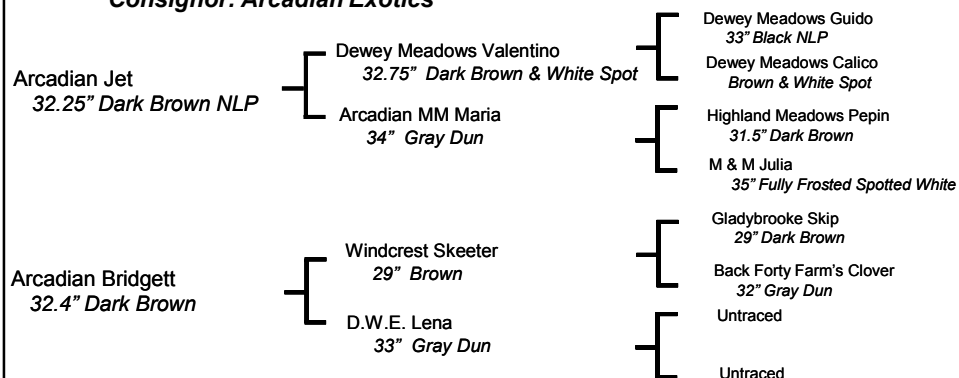
**Arcadian's *Bridgett's Black Beauty*****Black w/Cross NLP Jennet, Sept. 2, 2004, Reg Pending****Consignor: Arcadian Exotics**

This little jennet is outstanding. Black Beauty is black w/cross & a black muzzle, just a bit of tan across her nose and inside ears. She is sweet and friendly. Her Sire, Jet, is small, well built and out of one of our best producers. Black Beauty is Jet's first foal. Bridgett's previous 2 foals by Valentino have stayed small. Her grandsire Valentino has been producing solid blacks, including one out of Bridgett that was solid black, NLP, no cross. Black Beauty has a great future in your herd!

30

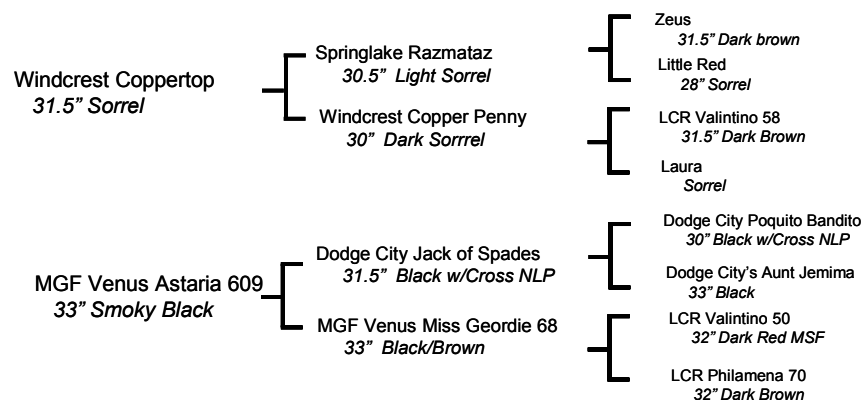
**Parkside *Blackberry Jammin'*****Dark Brown/Red Jennet, May 29, 2004, Reg Pending****Consignor: Parkside Ranch**

Blackberry is a beautiful dark brown jenny displaying rich sorrel highlights inherited from her father. With Coppertop's dark sorrel background and her mother being a black daughter of Dodge City Jack of Spades, she is sure to add lots of color to your breeding program. She is super sweet and so classy. Add her to your cart today!

31

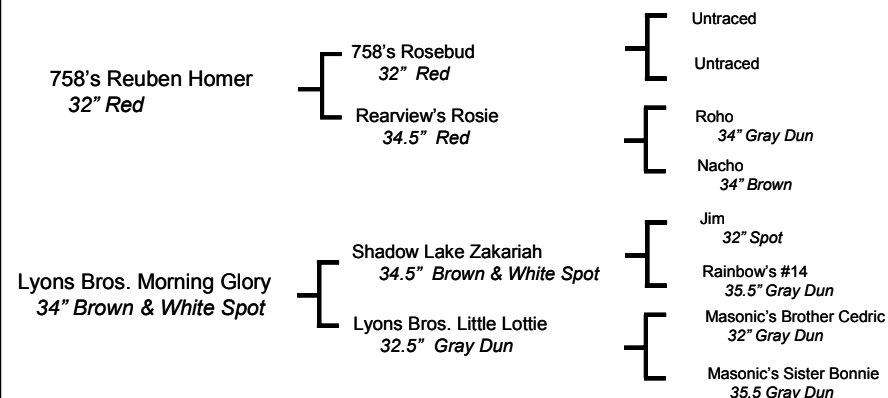
**Lyons Bros. *Little Lena*****Gray & White Spot Jennet, Apr. 13, 2004, #40269****Consignor: Lyons Bros. Farm, 28" in June, 2005**

This little jennet has great potential to be show quality or a great addition to your herd. Her grandsire was an Illinois State Champion. Her small size should interest any serious spot breeder.

32

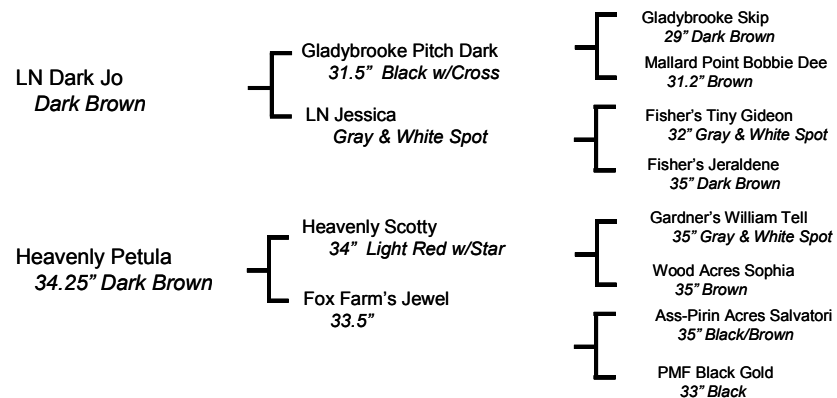
**Heavenly *Independence*****Dark Brown Jennet, July 18, 2004, Reg Pending****Consignor: Moore Mini Farms**

Heavenly Independence is a very dark chocolate jennet. Her Dam and Sire are black/brown. Her mother is an ex show jennet that did very well. Indy could do the same, since she is very easy to work with.

33

**Feather Ridge's *Latonia***

Dark Brown Jennet, July 23, 2004, Reg Pending

Consignor: Feather Ridge Farm

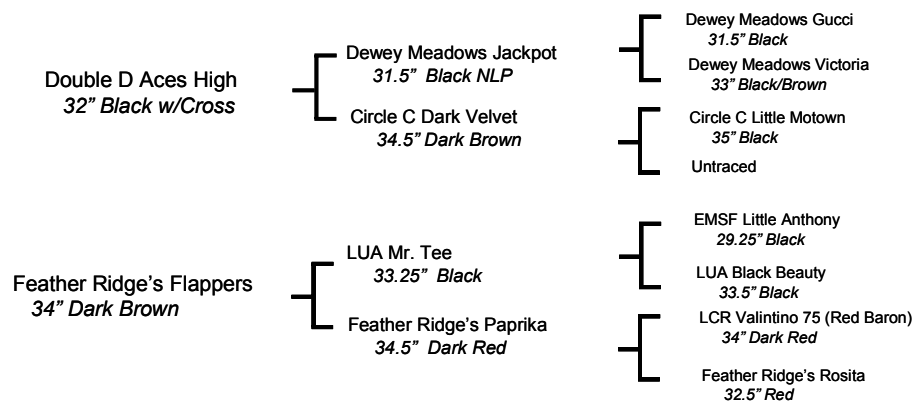

This little gal is a beautiful dark chocolate. Latonia's Dam, Feather Ridge's Flappers, also a chocolate, is out of Paprika, a bright red jenny and sired Mr. Tee, a black. With Latonia, you have the best of both worlds. She will complement any herd. Very loving and sweet disposition, and a well built jennet.

34

**MGF *Ebony and Ivory***

Dark Brown and White Spotted Jennet, June 23, 2004, #41775

Consignor: McRobert's Game Farm, 32.25" in June, 2005

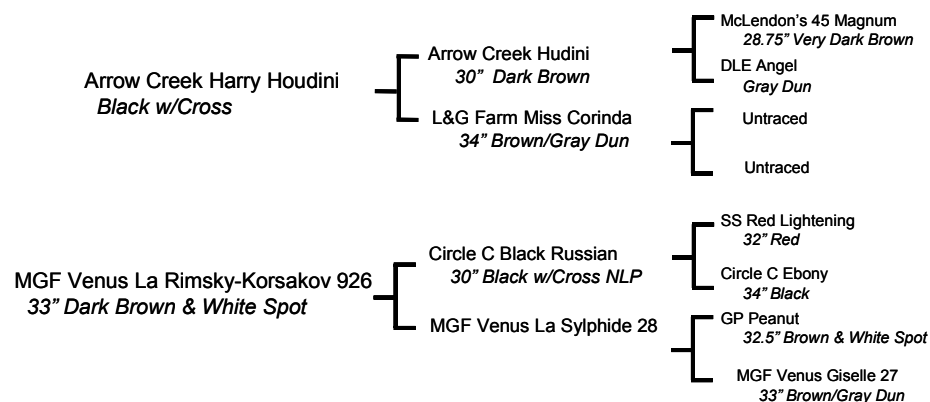

Probably the most exotic donkey we've ever raised....Spectacular color placement... Extremely Woolly.... A Long Haired Beauty!

35

**TomAsses *Little Brown Penny***

Light Brown/Gray Dun Jennet, Aug. 8, 2004, #41229

Consignor: Oleo Acres, 21" at Birth, 27" in Mar. 2005

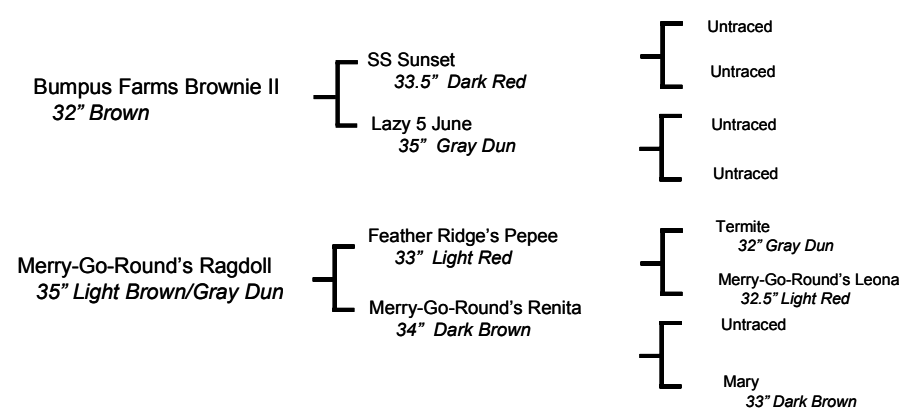

Great Little jennet going back to the Danby herd. Drafty build and she has a great butt. She has a very pretty head and has a wonderful personality. Her 2 year old full brother is 29.5" and she is following the same growth chart.

36

**Maxwell Ridge *Truly Divine***

Brown 29" Jennet, May 20, 2000, #CDJE-3561, Bred for 2006

Consignor: Maxwell Ridge Farm

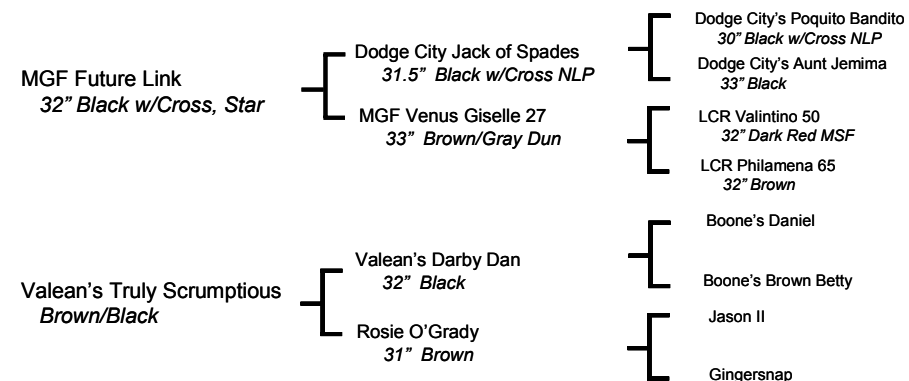

An exceptional petite jennet with plenty of style, class and pedigree to catch your eye. A daughter of Future Link, with a beautiful head, perfect bite, great conformation, and only 29". She is in foal to MRF Summer's Legend (31.5" Rose Dun), son of Circle C Legend and Circle C Summer Storm. This combination surely makes her "Truly Divine".

37

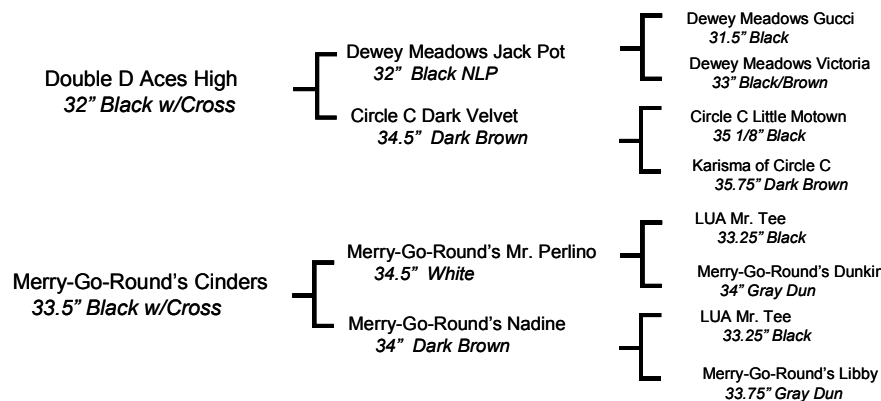
**Merry-Go-Round's *Silhouette*****Black NLP Jennet, July 14, 2004, #40681****Consignor: Merry-Go-Round Minis, 30.25" in Mar. 2005**

Silhouette is all black with no light points. She is a lovely jennet, by DD Aces High. She has an extensive black pedigree, and her dam Cinders is sired by Mr Perlino, so the crème gene could be there.

38

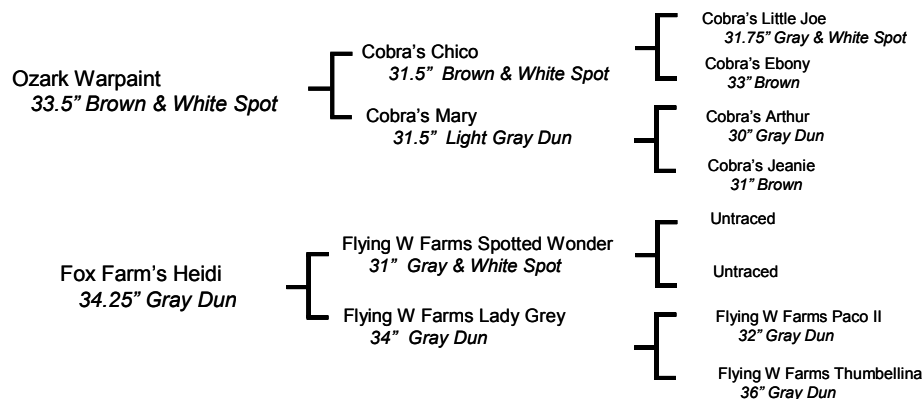
**Heavenly *Sable*****Gray & White Spot Roan Jennet, Sept. 4, 2003, #39669****Consignor: Little Bit of Heaven, 31.5" in Mar. 2005**

Sable is true to her name. She has a lot of color in her background, and she has gray & white roaning throughout her coat. Sable has a loving disposition and is blossoming into a beautiful jennet. She will be ready in September to be bred to your jack.

39

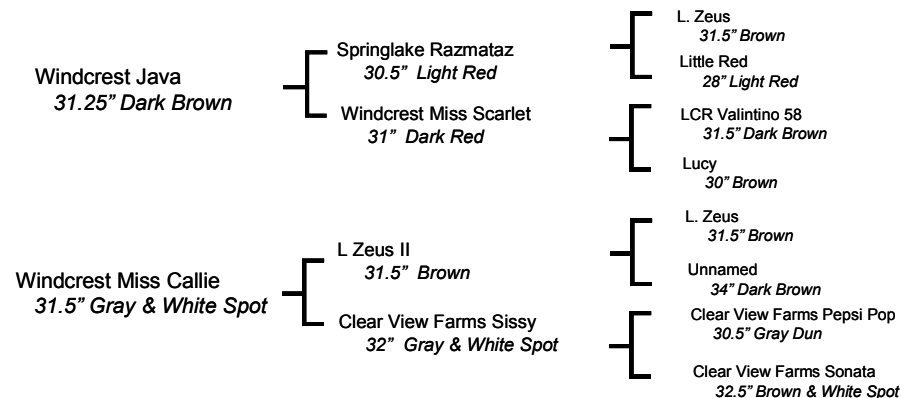
**Windcrest *Little Carly*****Brown/Gray Dun 32.25" Jennet, July 17, 2000, #28169, Bred for 2006****Consignor: Long Run Farm**

Carly is tiny and breathtakingly correct. You will not find a better conformed jennet. Her father is the good show jack Windcrest Java. She carries the bloodlines of Zeus and Valentino 58. She has produced one excellent black jack foal, and will be bred back to the same jack, a son of multiple National Champion Cash Dividend. This jennet is an investment in her own right.

40

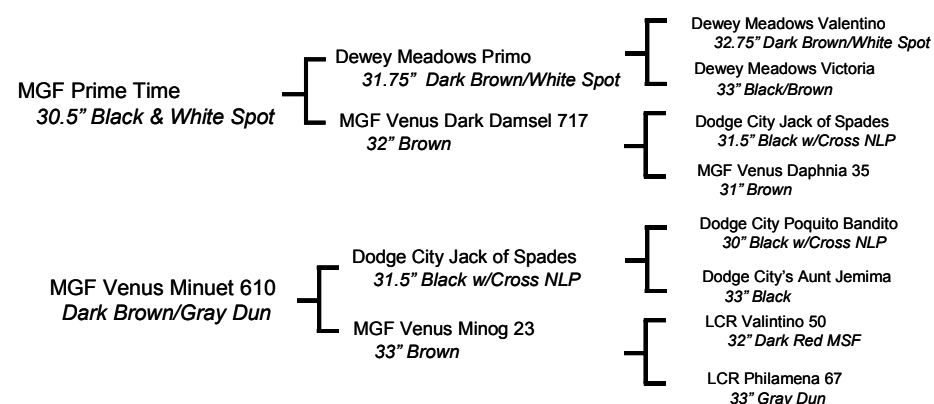
**MGF *Midnight Rhapsody 439*****Black Jennet, June 12, 2004, #41774****Consignor: McRoberts Game Farm, 31" in June, 2005**

Midnight is a stocky, black jennet by Prime Time, a 30 1/2" black and white spotted Primo son. Her dam is a 32" dark brown Jethro (Jack of Spades) daughter. Good conformation, legs and a quiet & very friendly nature.

41

**The Elms *Sedona Red***

Dark Red Jennet, May 6, 2004, #39179

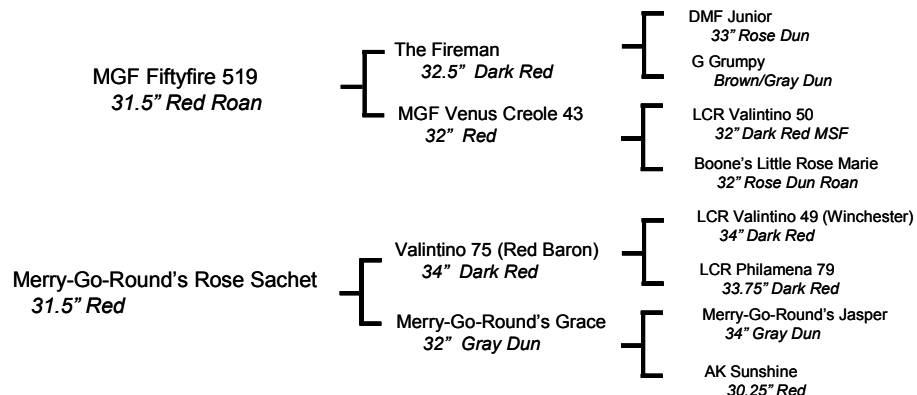
Consignor: *Elms Farm Miniature Donkeys, 20.5" at 2 days*

We were in Sedona, Arizona when this jennet was born, came home and said, "She's the same color as those beautiful red rocks"! With Fireman as one grandsire, and Red Baron the other, you know this jennet has very correct conformation. She will also stay small and she has a sweet personality. All topped off with that rich, deep red color! Sedona will glow in your herd!

42

**LN *Little Meteor***

Dark Brown Jennet, July 14, 2004, Reg Pending

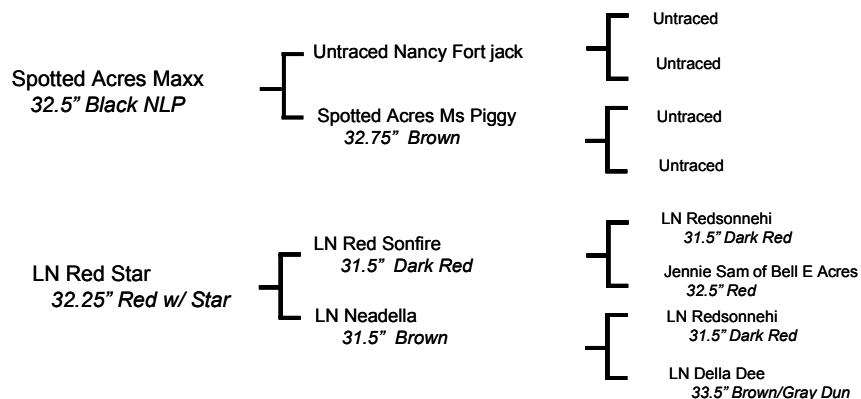
Consignor: *Nissen's Lazy N Ranch, 23" at 2 days, 31.75" at 10 months*

A very stylish, classy Maxx daughter, with a pretty head & neck that catches your eye like a meteor shooting across the sky. Her Dam, a deep red, has a great pedigree and is the linebreeding of the Multiple Halter & Performance Champion Redsonnehi. Sired by our great past herdsire Red Sonfire, Red Star is also a full sister to halter Champion, LN Beacon, one of the top 4 selling jennets at 2001 NASS. Two Maxx daughters are staying in our herd, no more until 2006. Make a list, then a wish, this Little Meteor is the perfect star for you.

43

**Hiwest *Twinkle***

Steel Gray, NLP 32" Jennet, June 5, 1997, #CDJE-2047, Bred for 2006

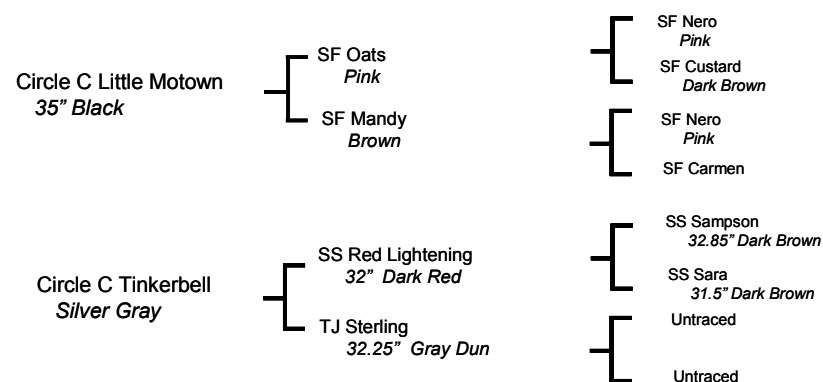
Consignor: *Maxwell Ridge Farm*

What's in a name? In the case of Twinkle, the name says it all. Twinkle is a very elegant, correct, charcoal small jennet from exceptional breeding programs (combination of Red Lightening/Little Motown). She is bred for a spring 2006 foal to MRF Summer's Legend (31.5" rose dun), son of Circle C Legend and Circle C Summer Storm. This package will definitely add a lot of "Twinkle" to your breeding program.

44

**HHA *Baby Phat***

Dark Brown Jennet, July 15, 2004, #39280

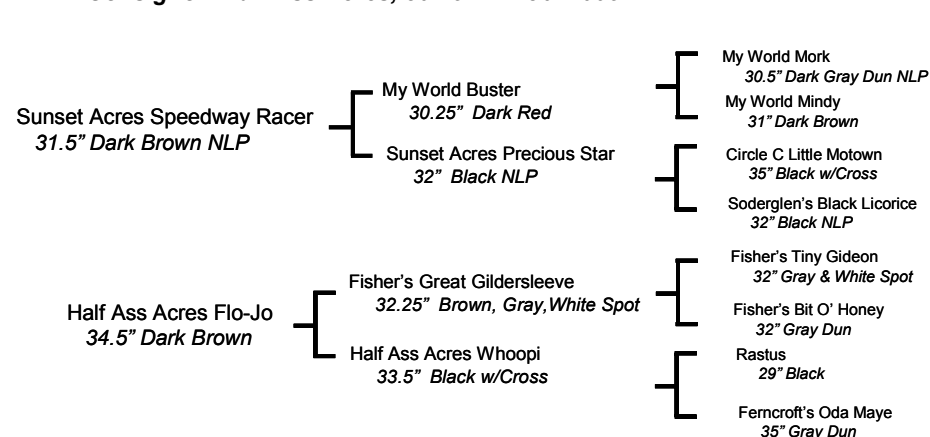
Consignor: *Half Ass Acres, 30.15" in Feb. 2005*

She's Phat...physically attractive! Baby Phat is a people donkey and loves attention. She is sired by a 31" black/brown NLP jack. She has dark sorrels, blacks and spots throughout her pedigree. She will do well in the show ring and later will make an outstanding brood jennet.

45

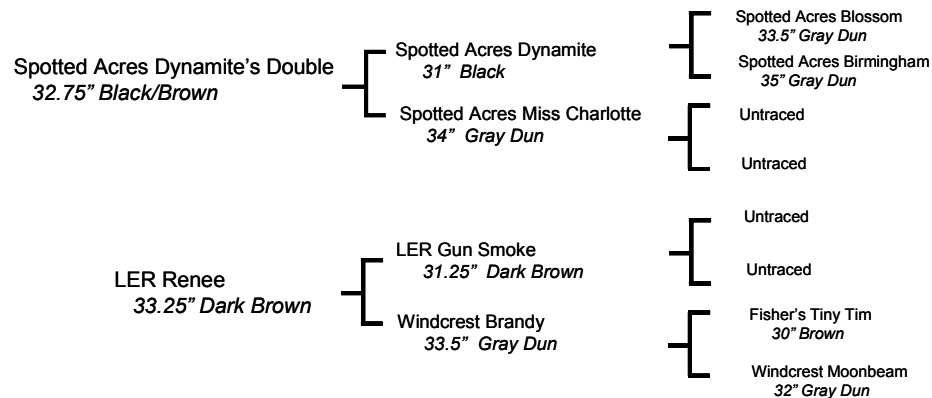
**LER *Miss Hospitality*****Black Jennet, May 6, 2004, Reg Pending****Consignor: Lamb's Exotic Ranch, 20.75" at Birth, 28.5" in Mar. 2005**

An exceptional, nice black jennet, that certainly will be an asset to any one herd of donkeys. Great body conformation, a real sharp built jennet, correct bite, real straight legs and a wonderful disposition. Sired by a good black jack and her Dam is a dark brown jenny that has produced real nice foals for me. This jennet won't get big on you, she will stay small.

46

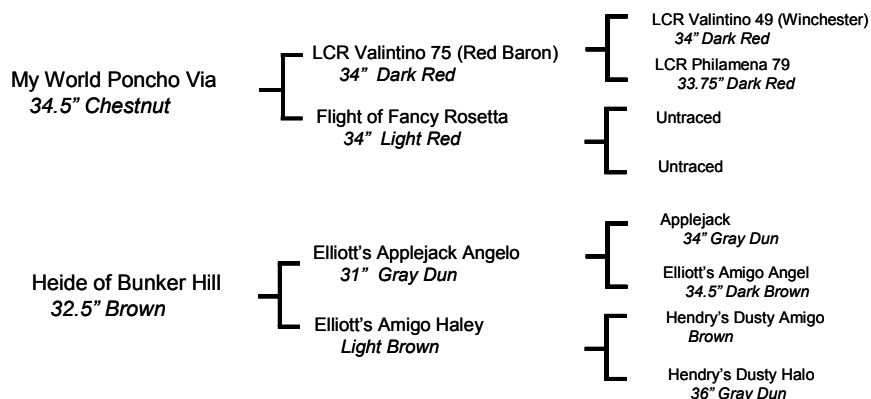
**Bunker Hill *Caramel Candy*****Gray Dun Jennet, Apr. 30, 2002, #CDJE-3805, Bred for 2006****Consignor: Bunker Hill, 31.75" in Mar. 2005**

Candy has the breeding and conformation to be an asset to any breeding program. If you follow the show results, you will recognize her Sire. She is in foal to 758's Rosso, a dark sorrel, for 2006.

47

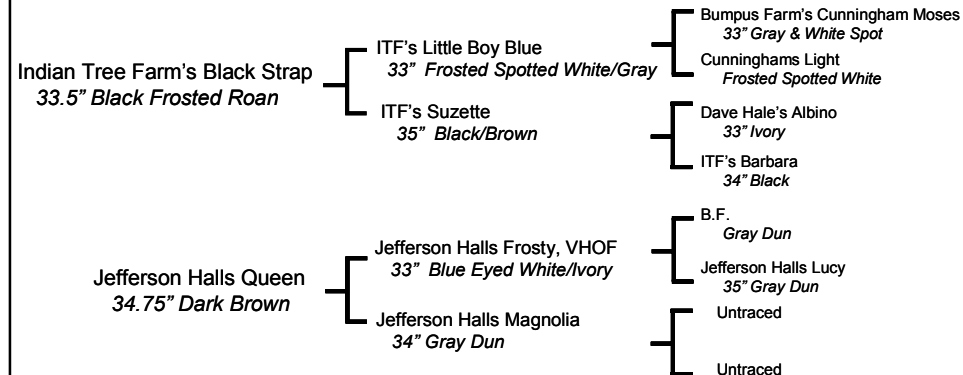
**Windcrest *Katie*****Dark Brown Roan 35.75" Jennet, Bred for 2006, Harness Trained****Consignor: Long Run Farm, Sept. 3, 1994, Reg # 25233**

Katie was shown in driving classes for one season in 2001 and took a blue ribbon in every class except one (that was red). She won reinmanship and obstacle at the Ohio State Fair and won driving at the SW OH Draft Horse Show. She has produced 3 great babies for us and is being bred to our spotted jack, Thom-Ass Cobra's Commanche. With Katie's dark brown roan, they should produce a beautiful, colorful foal.

48

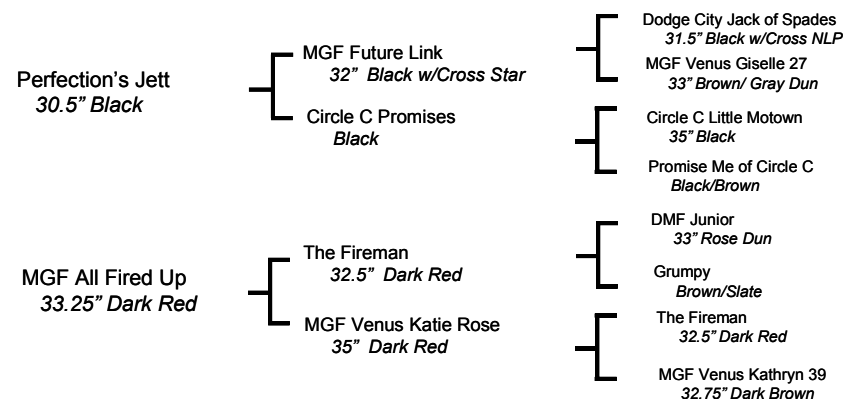
**Perfection's *All About Me*****Russet Brown Jennet, Sept. 22, 2004, Reg Pending****Consignor: Perfection Miniature Donkeys, 20.5" at Birth**

What's the old saying...If it isn't broken don't fix it? Well, we thought that All Jetted Up purchased last year at this sale by Tom and Deb Cochran was so special that we needed to try that cross again. Lady Luck was with us and granted us another beautiful foal!

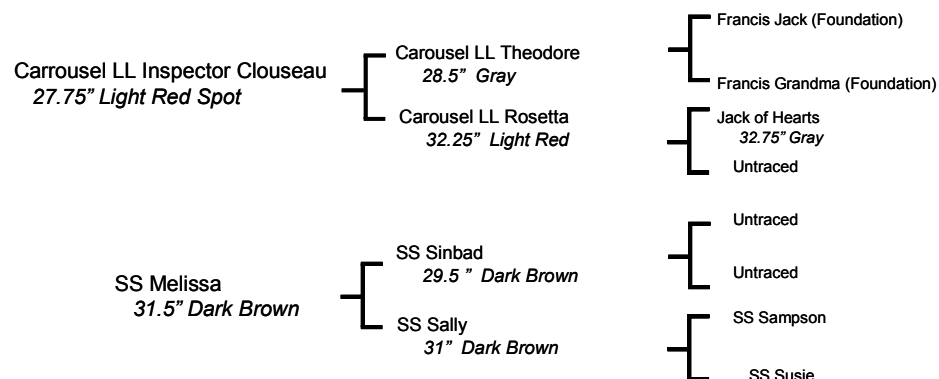

**49****Heiken's Ark *Mira C*****Rose Dun Jennet, June 21, 2004, Reg Pending****Consignor: Heiken's Ark**

Mira C is one of the first Inspector Clouseau daughters we have offered for sale. She had a very unique tan/light red color when she was born. Mira C promises to add something new in your bloodlines and breeding program.

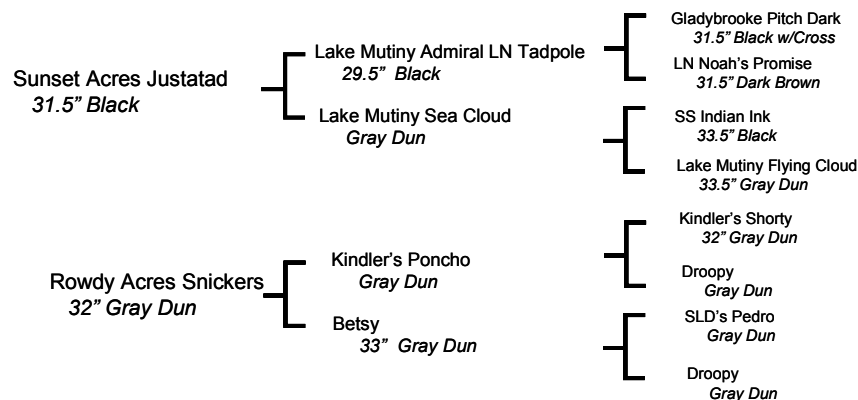
**50****Sunset Acres *Baby Snickers*****Black/Brown no stripe Jennet, Mar. 30, 2004, #42034****Consignor: Sunset Acres, 22" at Birth**

Baby Snickers has a nice full pedigree which includes black and red genetics. The topside includes donkeys from the LN and Stansbury lines. The maternal side has produced reds from Luigino heritage. Looks like she will be a nice, stocky female.

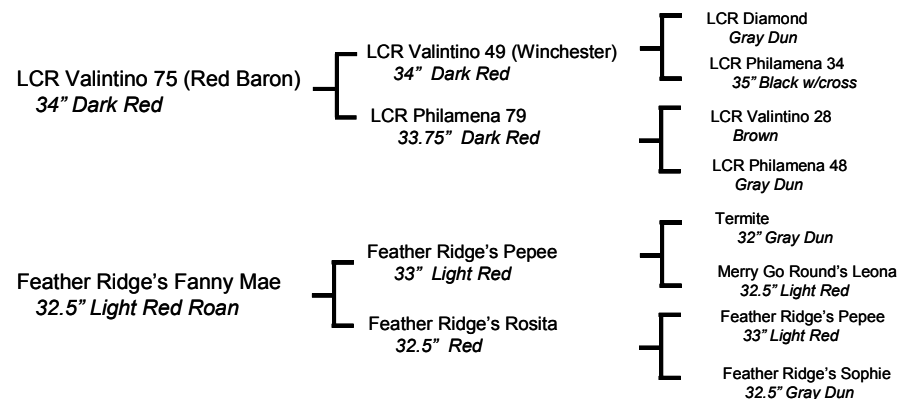
**51****Feather Ridge's *Mavis*****Dark Sorrel 34.5" Jennet, May 23, 1995, #21053, Bred for 2005****Consignor: Feather Ridge Farm**

Mavis is a Red Baron daughter with good red color, a wonderful brood jenny. She is bred to My World Parker for summer 2005. A great mother, she puts good stocky babies on the ground. Bred to sorrel, she throws rich red color. Here is an opportunity to own a proven jennet who has beautiful babies.

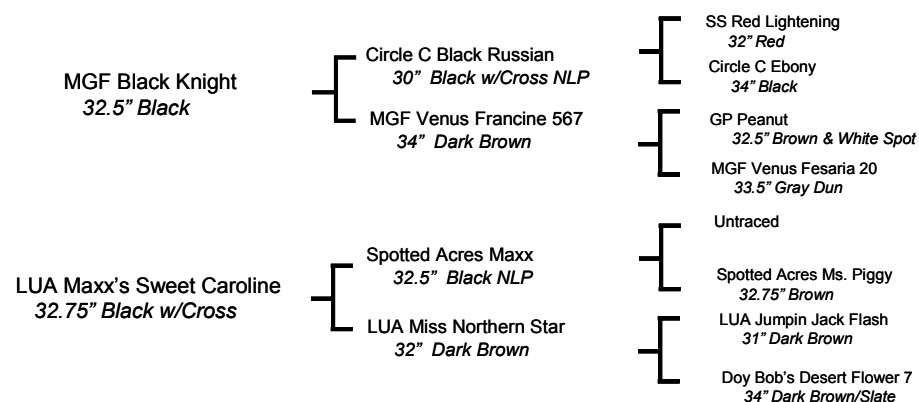
**52****The Elms *Black Satin*****Black Jennet, Sept. 10, 2004, #40222****Consignor: Elms Farm Miniature Donkeys, 22.25" at Birth**

She has hair as fine and smooth as satin, and shiny black. She had to be named Black Satin! This is a ladylike jennet, very dressy. Satin has that glossy sheen Black Knight gives his black foals which really sets them apart. She has a nice chest, great teeth and sweet personality. She is developing very nicely, and we think you will like what you see!

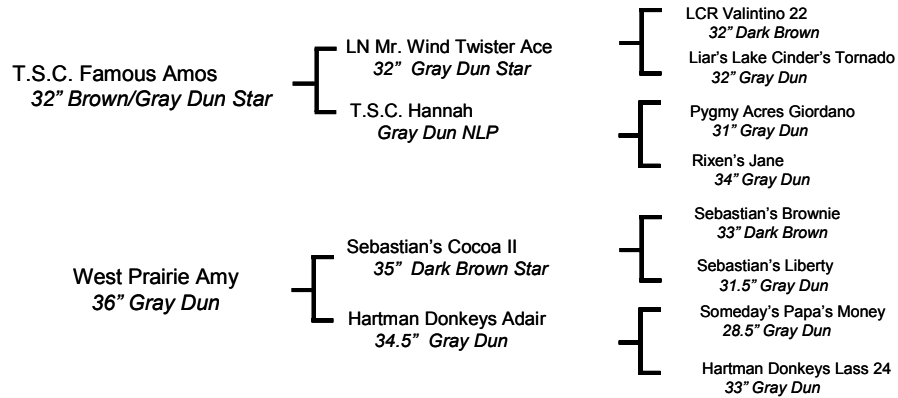
**53****West Prairie *Alley*****Gray Dun Jennet, Apr. 13, 2004, Reg Pending****Consignor: West Prairie Farm, 23" at Birth, 30" in Mar. 2005**

Alley is by T.S.C. Famous Amos, 32" tall. She is a very sharp gray dun. She has dark genes and her black stripe comes from her grandfather. She is gentle with great conformation. Her full sister was in last year's sale, West Prairie Amber. Jennys run in the family, a real sweet jenny.

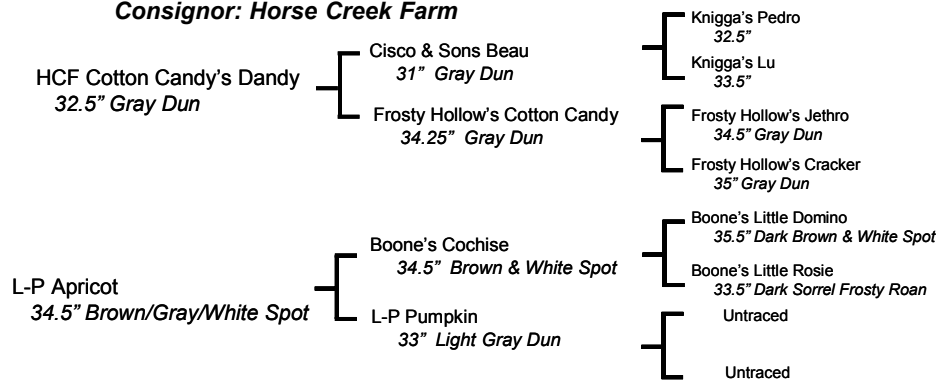
**54****H.C.F. *Holiday Joy*****H.C.F. *Joy's Artful Dodger*, Jack Foal****Brown 32" Jennet, Dec. 29, 1998, #28647****Red/Brown Jack, May 15, 2005, Reg. Pending, 20.5" at Birth,****Consignor: Horse Creek Farm**

Born just after Christmas, Holiday Joy is a gray-brown little jennet, with a nice straight top line and compact body. Joy has a nice pedigree and excellent spot potential. Dodger's sire is our stocky, little, jack, Rose Wood Little Red Rover (32.5" light red, frosted roan, by Rearview's Red Rock, 32.5" dark red, out of Feather Ridge's Fanny Mae, 32.5" light red). Dodger is really nice, you can't go wrong with this pair. Joy's full brother, HCF Packy sired Q-T-Pa-2-T, Lot 21.

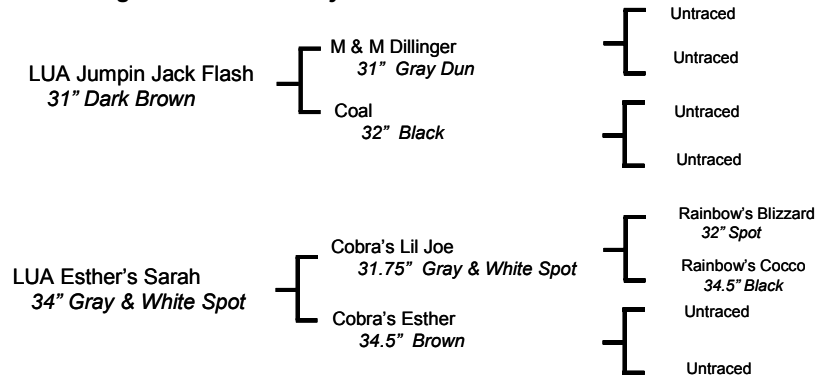
**55****LUA *Flash's Mercy*****Gray Dun 32" Jennet, Apr. 13, 1996, #16871, Bred for 2005****Consignor: Nissen's Lazy N Ranch**

Mercy is a nice gentle, stocky jennet, from 2 show parents. Her Sire was a really great 31" dark brown jack generally took blue every time shown, even beating the great Nicodemus. Her Dam was a lovely spot show girl (Cobra line). Mercy has awesome babies and is due to foal early July by our black jack, Déjà Vu, 30.5" @ 2 years. In 2004, Vu was Grand Champion MN & Reserve KS State Fair - all sizes/ages of donkeys & Grand Champion NE State Fair - minis, all ages. Here's a great way to get a Vu baby & a good producing, small jennet.

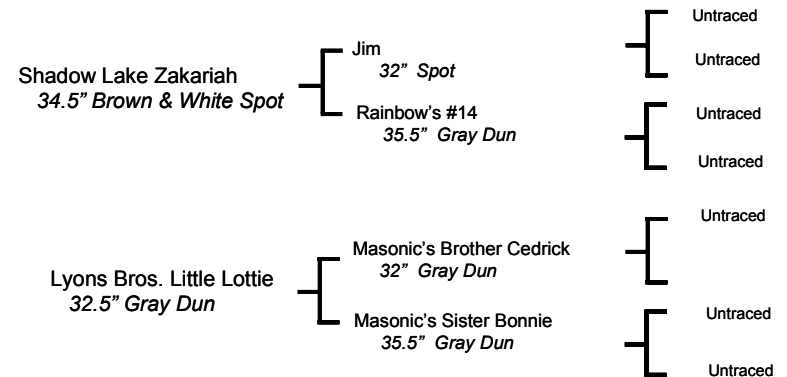
**56****Lyons Bros. *Morning Glory*****Brown & White Spot 34" Jennet, Apr. 11, 2001, #33244****Consignor: Lyons Bros. Farm, 33.25" in June, 2005**

Morning Glory has a good pedigree that has produced small babies year after year. The sire of this jennet was an Illinois State Champion. She would make an excellent jennet to show or add to your breeding program. Her last year's jennet (Lyons Bros. Little Lena) is Lot 31 in this sale.

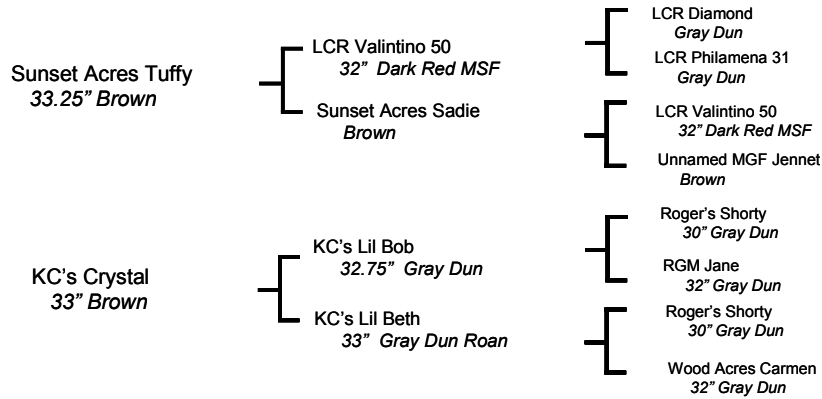
**57****LER *Crystal's Gem*****Dark Brown 32.75" Jennet, Aug. 10, 1999, #33186, Bred for 2005**  
**Consignor: Lamb's Exotic Ranch**

Gem is a jewel of a jennet, a top quality female donkey. Easy breeder and good producer. Good straight legs, correct bite and wonderful disposition, plus great body conformation. Shown only once, Gem placed 2nd in her class at 2001 Nebraska State Fair. Hope to have her bred back by sale time to a good 32.5" black jack, Dynamite's Double.

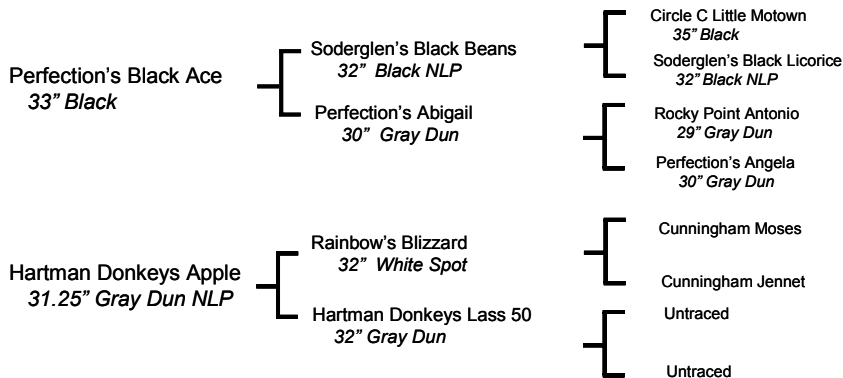
**58****Perfection's *Rosy Apple*****Gruella Jennet, Aug. 24, 2001, Reg Pending, Bred for Fall 2005**  
**Consignor: Perfection Miniature Donkeys, 20" at Birth**

Not for sale! No, that is Val's favorite, well the Howard's wanted a great one and here she is! Rosy is small, square, a beautiful gruella color, and she is due this fall for a Jett foal. A lap donkey extraordinaire, Rosy insists on checking out everything that is happening on the farm and in your pocket. Take her home, love her and be SURE to call Val the moment the foal is born...because it is sure to be a STAR!!

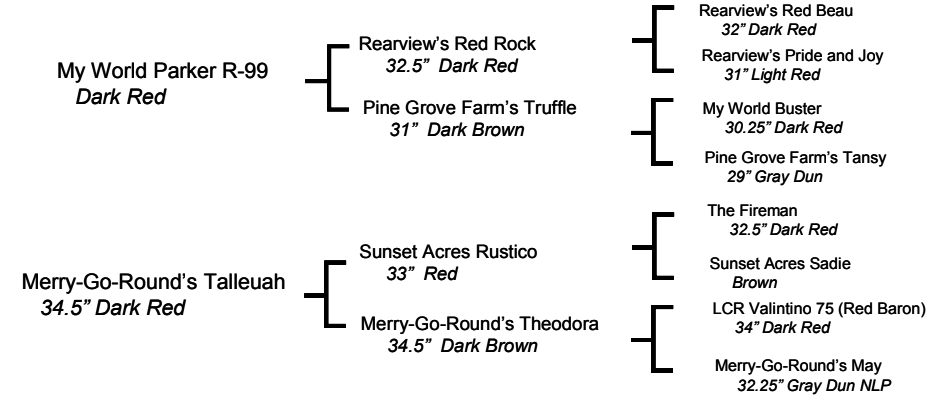
**59****Merry-Go-Round's *Lady Bug*****Red Jennet, Mar. 27, 2003, #40680**  
**Consignor: Merry-Go-Round Minis, 31.5" in Mar. 2005**

Lady Bug is the last sorrel I bred for. Her dam, Talleuah is a dark red sorrel. Her full sister, Sienna, sold well at the 2003 NASS. Lady Bug is small, compact, correct and drafty, like her sire My World Parker. She is a lovely red jennet and will be over 2 years old at sale time. She is currently 31.5" tall. She is loaded with sorrel from Red Baron, FR Pepee (Sire of May), Rustico, and My World. A plus for any sorrel breeding program.

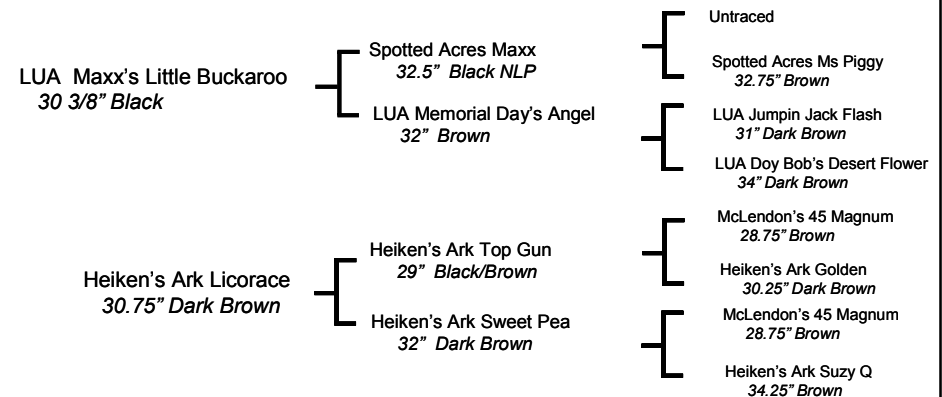
**60****Heiken's Ark *Libby LB*****Black Jennet, Aug. 2, 2004, Reg Pending**  
**Consignor: Heiken's Ark, 20.5" at Birth, 24.75" in Nov. 2004**

This little black jennet was only 20.5" when she was born. Her sire, Maxx's Little Buckaroo, is black with no cross and her dam is a very dark brown Magnum granddaughter. She is special.

**61****MGF *Crimson Crème* 490**

Light Red &amp; White Spot Jennet, Aug. 26, 2004, #41773

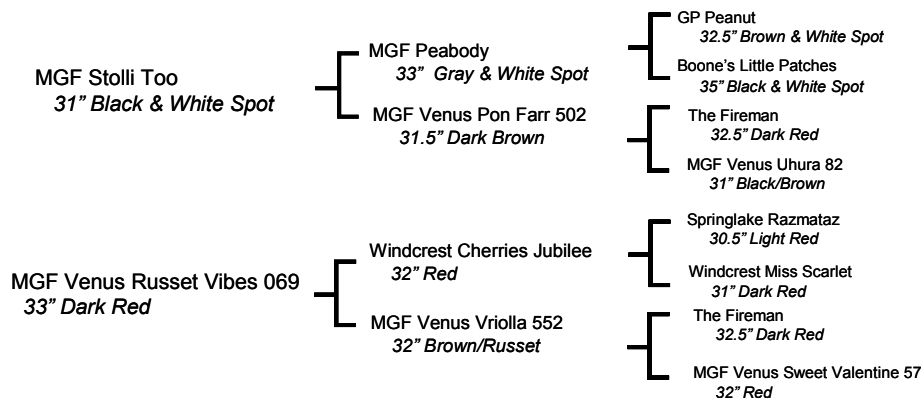
Consignor: *McRoberts Game Farm, 30.5" in May, 2005*

This light red spotted sorrel is stocky, woolly and uniquely colored. *Crimson Crème* is by our 32" super hairy black and white spot - MGF Stolli Too. Her Dam is a dark sorrel *Cherries Jubilee* daughter. A beautiful cream color splashed with red gives her her name. She is friendly and elegant and lights up the field.

**62****The Elms *Unity***

Dark Brown Jennet, June 12, 2004, Reg Pending

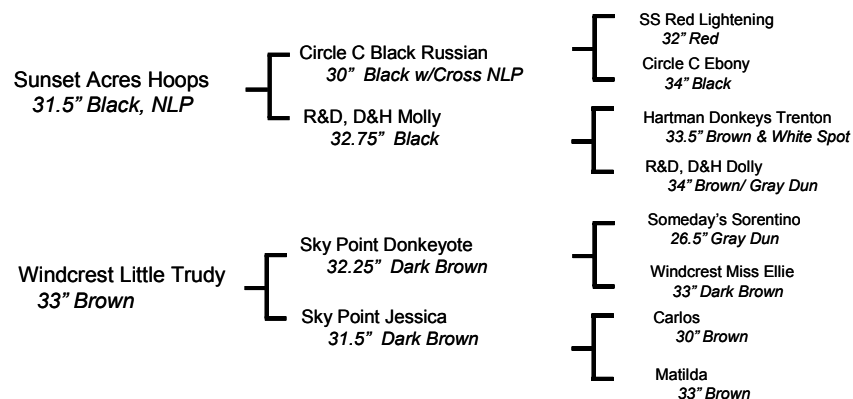
Consignor: *Elms Farm Miniature Donkeys, 28.75" in May 2005*

A tiny dark daughter of Hoops, an exceptional all black jack! *Unity's* name comes from her birth on a wedding day! Also from the union of two bloodlines, the famous Black Russian line, and Donkeyote, the progenitor of another black line. We expect her to stay very small. Last of the Sale, but worth waiting for!

**Substitutions, Notes , Changes, Corrections****15 - Scratch due to illness****39 – Bred this week to Cash Box - exposed****57 – Crystal's Gem Bred last week to same jack, for 2006, did not take for 2005.****Notes:**

2

### Perfection's *Acentina*

### Perfection's *Jettina*

Brown Jennet, Mar. 9, 2000, 42280, Bred for 2006

Brown Jennet Foal, June 21, 2005, Reg. Pending, 22" at Birth

Consignor: Perfection Miniature Donkeys, 21.75" at Birth

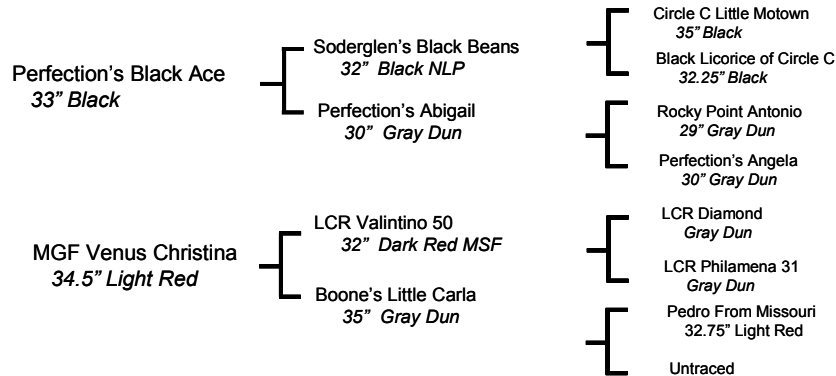

What a Package!! Acentina is half sister to our sorrel high sellers. She is well built, a Black Beans granddaughter & has a pedigree tracing to the imports. Then, a gorgeous Jett foal by her. These Jett foals are fantastic, and as we don't outside breed him, the only way to get one is to buy one. Want more? OK, Acentina is bred back the same way!! 3 in 1. How much better can you get?

58

### Perfection's *Apple Pie*

Gruella, NLP Jennet, May 1, 2003, 42286, Bred for 2006

Consignor: Perfection Miniature Donkeys, 20" at Birth

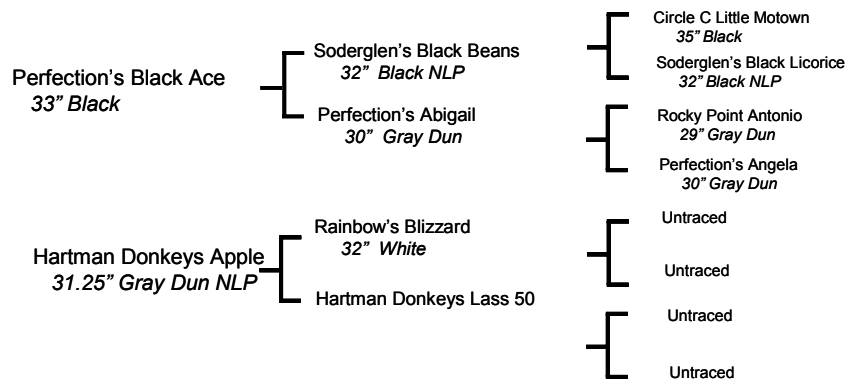

Substitution:

The Apple falls not far from the tree with this substitution - a half sister to the original offering and Bred to Perfections Jett for 2006 too. Rosy Apple is from the same sire, perfection's Black Ace - a dynamite jack. You won't miss a beat with her.

## 2005 Sale Donkey List

Lot #	Miniature Donkey	Lot #	Miniature Donkey
1	The Elms Bonnie Glow	32	Heavenly Independence
2	Perfection's Misty Mystical	33	Feather Ridge's Latonia
3	MGF Pink Champagne	34	MGF Ebony and Ivory
4	Heiken's Ark Bubbles T	35	TomAsses Little Brown Penny
5	Feather Ridge's Schwanda	36	Maxwell Ridge Truly Divine
6	Lucky Star's Inky Dinky Doodle	37	Merry-Go-Round's Silhouette
7	Bunker Hill Lady in Red	38	Heavenly Sable
8	LER Knite-N-Gail	39	Windcrest Little Carly
9	Valean's Carmelita	40	MGF Midnight Rhapsody
10	HHAA She Bangs	41	The Elms Sedona Red
11	The Elms Vivi Va Voom	42	LN Little Meteor
12	MGF Red Hot Mama	43	Hiwet Twinkle
13	Perfection's Just Divine	44	HHAA Baby Phat
14	Heiken's Ark Lolita	45	LER Miss Hospitality
15	LN Jessa Little Mop	46	Bunker Hill Caramel Candy
16	Sunset Acres Mystic Myryha	47	Windcrest Katie
17	J & E Carmen	48	Perfection's All About Me
18	Heavenly Lu Lu	49	Heiken's Ark Mira C
19	The Elms Firelight	50	Sunset Acres Baby Snickers
20	Feather Ridge's Glimmer	51	Feather Ridge's Mavis
21	HCF Q-T-Pa-2-T	52	The Elms Black Satin
22	West Prairie Jenna	53	West Prairie Alley
23	Merry-Go-Round's Nighten Gale	54	HCF Holiday Joy
24	Long Run's A Star is Born	55	LUA Flash's Mercy
25	Heiken's Ark Jodi F	56	Lyon Bros. Morning Glory
26	Perfection's Itsy Bitsy Blossom	57	LER Crystal's Gem
27	The Elms Precious Jewel	58	Perfection's Rosy Apple
28	MGF Think Pink	59	Merry-Go-Round's Lady Bug
29	Arcadian' Bridgett's Black Beauty	60	Heiken's Ark Libby LB
30	Parkside Blackberry Jammin'	61	MGF Crimson Creme
31	Lyons Bros. Little Lena	62	The Elms Unity

See [WWW.DONKEYS.NET](http://WWW.DONKEYS.NET) for Pictures

## 2006 Great American Miniature Donkey Sale

Sale Day - July 29, 2006

Now is the time to select those special donkeys you will want to represent your farm breeding program in the 2006 Sale. Sale planning begins in December, deadline in February. Contact us anytime to discuss potential entries and details.



**Elms Farm Miniature Donkeys**

The Elms Farm

Martha & Dowell Howard

5600 Bethany Road

Mason, OH 45040

513-398-3341

**WWW.DONKEYS.NET**

donkeys@donkeys.net

**FIRST CLASS**